

smart interior design

FOR YOUR OFFICE

WWW.SMARTINTERIOR.RO

Executive MITO

v4.2021

Colour combination - Mito

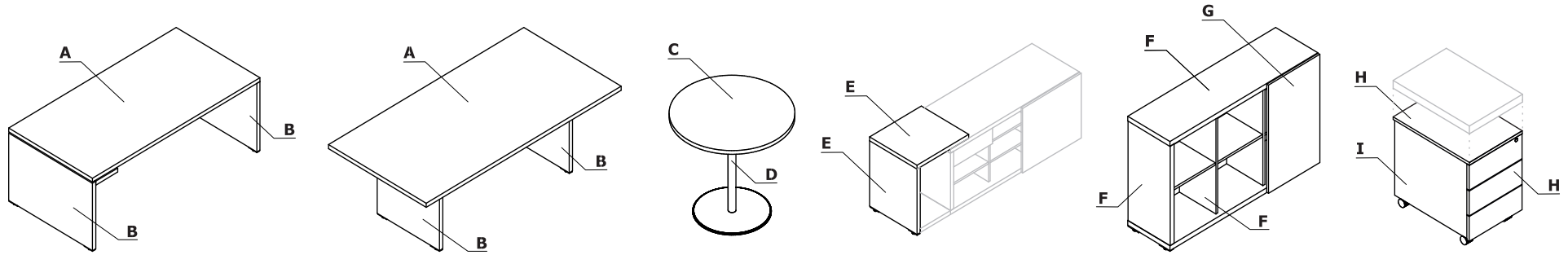

Material	Colour	Desks, MIT11		Tables - disc base		MIT5	Storages with HPL front		Mobile pedestal without handles (SLD12HT, SLD13HT)		Mobile pedestal without handles (MIT120, MIT130)		Desks with managerial storage	Grommet		
		A - Top	B - Base - HPL	C - Top	D - Supporting leg	E - Extension	F - Top, base, body	G - Front	H - Top, front	I - Body	H - Top, front	I - Body				
MFC	172 - amber oak	✓		✓			✓				✓	✓	Grey			
	173 - robinia	✓		✓			✓				✓	✓	Black			
	67 - white pastel									✓						
	08 - black									✓						
HPL	73 - white high gloss		✓			✓		✓	✓							
	101 - black high gloss		✓			✓		✓	✓							
	155 - anthracite high gloss		✓			✓		✓	✓							
Metal	M009 - aluminium semi-matt RAL 9006				✓											
	M015 - white semi-matt RAL 9010				✓											
	M115 - black semi-matt RAL 9005				✓											
	M154 - anthracite semi-matt RAL 7043				✓											

Colour combination - Mito

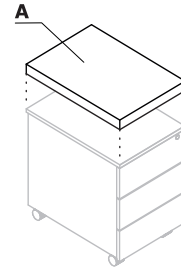

Material	Colour	Pedestal cushion												
		A - SKP13												
Fabric	Nemo	✓												
	Runner	II group ✓												
	Medley	II group ✓												
	**Atlantic	II group ✓												
	Vita	II group ✓												
	River	II group ✓												
	Xtreme	III group ✓												
	Synergy	III group ✓												
	***Silvertex	III group ✓												
	Atlas	IV group ✓												
	Field2	IV group ✓												
	*Customer's own fabric	II group ✓												

* Employing the customer's fabric requires running upholstery tests in order to check the possibility of realisation.

*** There is a possibility of ordering the product in full colour spectrum of Silvertex range, as per Spradling's pattern book, within 15 working days.

** There is a possibility of ordering the product in full colour spectrum of Atlantic range, as per Gabriel's pattern book, within 8 weeks

Desks

- 1 Worktop** - MFC 38 mm, ABS edge
- 2 Top** - MFC 38 mm, ABS edge
- 3 Base** - MFC 38 mm, ABS edge
- 4 Body** - MFC 18 mm, ABS edge
- 5 Sliding front** - MFC 18 mm, ABS edge
- 6 Front** - MFC 18 mm, ABS edge
- 7 Central lock** - foldable key
- 8 Modesty panel** - MFC 18 mm, ABS edge
- 9 HPL base** - high gloss - 38 mm
- 10 Mediaport S91E** - OPTION WITH EXTRA CHARGE - 2x 230V, 2x RJ45

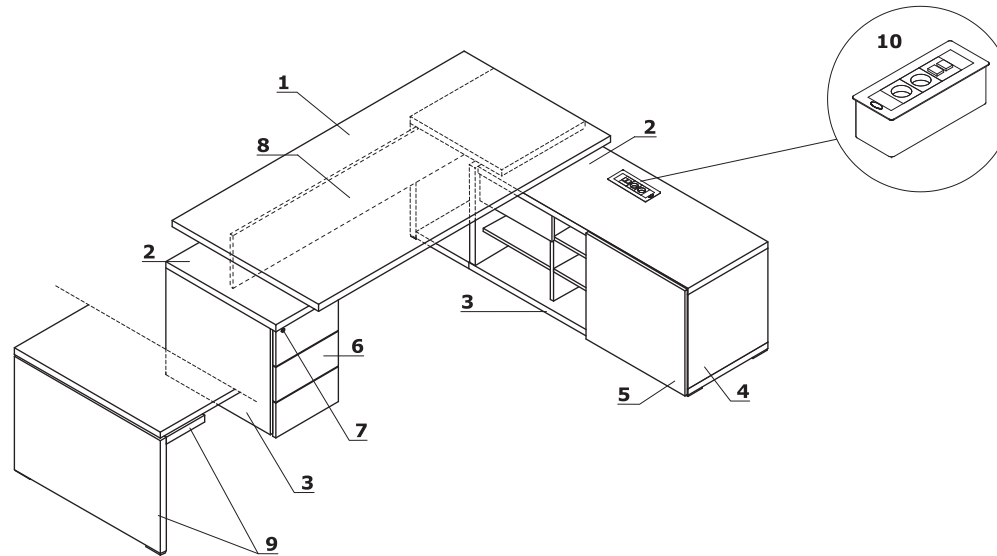

Configuration examples (mm)

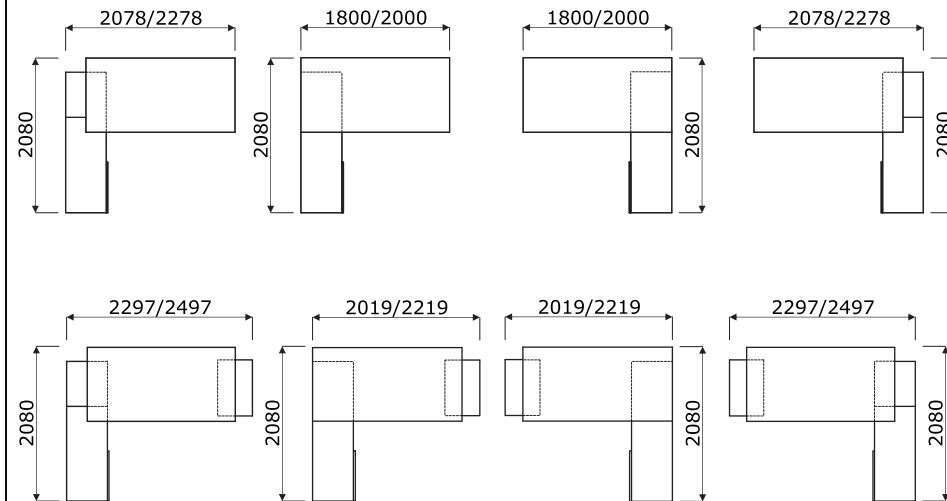

Managerial storages

- 1 Top** - MFC 38 mm, ABS edge
- 2 Front** - MFC 18 mm, ABS edge
- 3 Interior** - MFC 18 mm
- 4 Drawer** - MFC 18 mm, ABS edge, patent lock - possible to change location
- 5 Side panels** - MFC 38 mm, ABS edge
- 6 Mediaport S91E** - OPTION WITH EXTRA CHARGE - 2x 230V, 2x RJ45
- 7 Cable grommets** - Ø80 mm

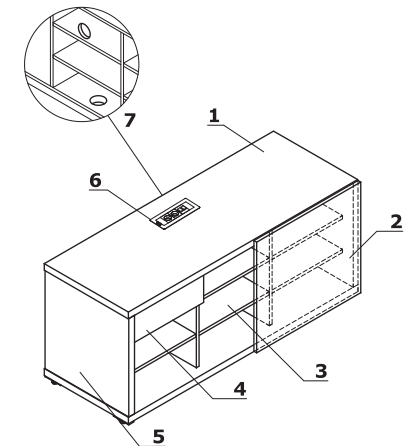

Deks with electric height adjustment and managerial storage

- 1 **Worktop** - MFC 38 mm, ABS edge
- 2 **Sliding front** - MFC 18 mm, ABS edge
- 3 **Drawer** - MFC 18 mm, ABS edge, possible to change location
- 4 **Electric height adjustable frame** - powder coated steel, load 100 kg, telescopic leg 60/60, 50/50, 40/40 mm
- 5 **Control panel**
 - A - up and down keypad with memory; the ability to change the sensitivity of the anti-collision system within 3 levels: Low, Medium, High
 - B - OPTION FOR AN ADDITIONAL COST to panel A - bluetooth module - control via MDD Desk BT application (downloadable from Google Play or App Store). The app has a time interval function that informs the user about the need of changing body position (from sitting to standing or standing to sitting)
- 6 **Mediaport S91E** - OPTION WITH EXTRA CHARGE - 2x 230V, 2x RJ45
- 7 **Cable grommets**

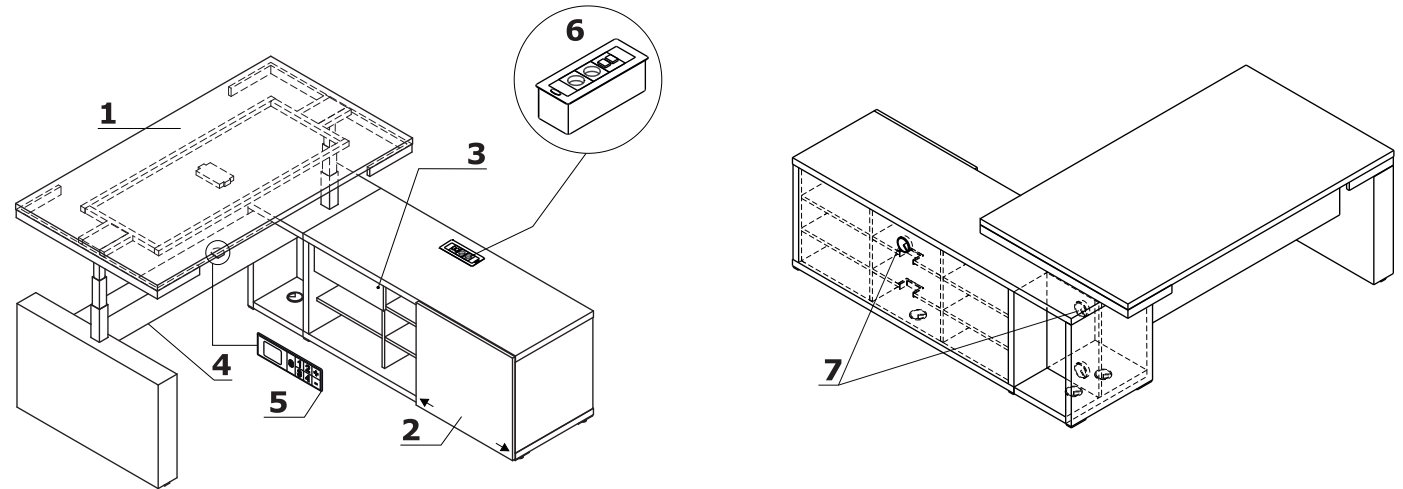

Frame technical specification

- **Height adjustment** - 40 mm/sec Super Soft Start - Stop
- **Drive** - 2 synchronised motors with microprocessor, work control sensor
- **ISP** - Intelligent System Protection
- **Standards** - EN 527-2
- **EU Directives** - 206/95EC, UI508 1999, UL 1004 R7 06, WE DC 2004/108WE
- **Power supply** - 230V, 300W, power consumption on Standby - 0.3W

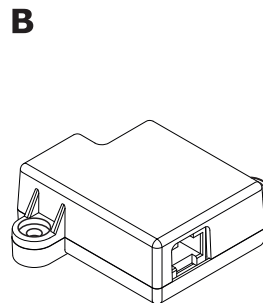
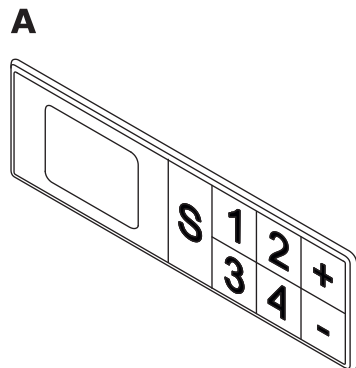

Filing drawers storages

- 1 **Top** - MFC 38 mm, ABS edge
- 2 **Aluminum handle**
- 3 **Front** - HPL - high gloss
- 4 **Central lock** - foldable key
- 5 **Side panels** - MFC 18 mm, ABS edge
- 6 **Suspension files drawer** - MFC 18 mm, ball runners, max load 45kg, 100% extraction
- 7 **Leveling** - 5 mm range

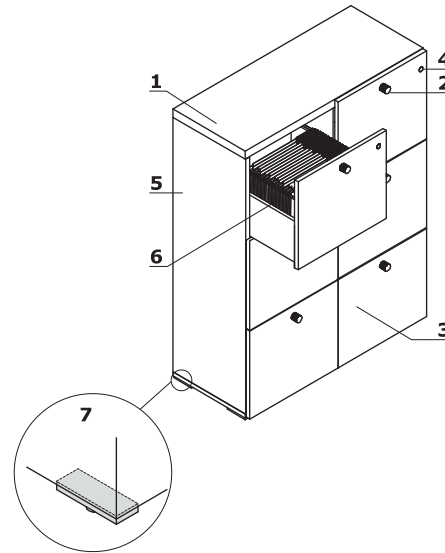

Sliding door storages

- 1 **Top** - MFC 38 mm, ABS edge
- 2 **Side panels** - MFC 38 mm, ABS edge
- 3 **Interior** - MFC 18 mm
- 4 **Base** - MFC 38 mm, ABS edge
- 5 **Sliding front** - MFC 18 mm, ABS edge
- 6 **Leveling** - 5 mm range

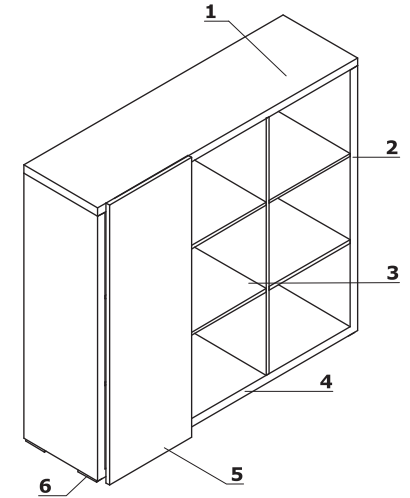

Sliding front storages MIT7 / MIT18

Storages

- 1 **Top** - MFC 18 mm, ABS edge
- 2 **Side panels** - MFC 18 mm, ABS edge
- 3 **Shelf** - MFC 18 mm, protection against accidental falling-out, ABS edge
- 4 **Base** - MFC 18 mm, ABS edge
- 5 **Back MFC** - 18 mm, ABS edges
- 6 **Leveling** - 5 mm range
- 7 **Espagnolette lock in doorknob**

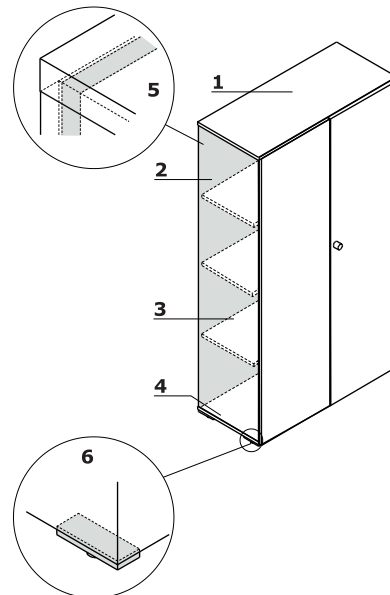

Disc base meeting tables

- 1 **Worktop** - MFC 38 mm, ABS edge
- 2 **Column** - powder coated steel
- 3 **Disc** - stainless steel INOX, powder coated

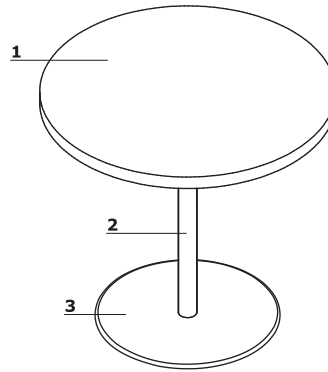

MFC base meeting tables

- 1 **Worktop** - MFC 38 mm, ABS edge
- 2 **HPL base** - high gloss - 38 mm
- 3 **Modesty panel** - MFC 18 mm, ABS edge
- 4 **Leveling** - 5 mm range
- 5 **Mediaport S91E** - OPTION WITH EXTRA CHARGE - 2x 230V, 2x RJ45
- 6 **Mediaport S92E** - OPTION WITH EXTRA CHARGE - 4x 230V, 4x RJ45

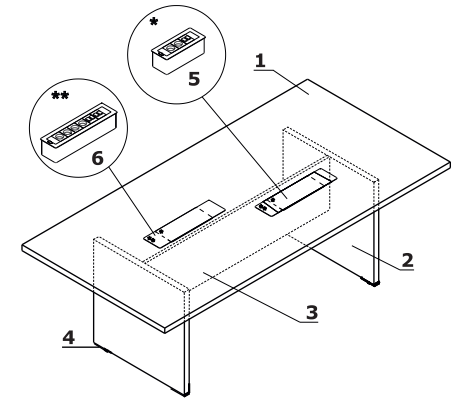

ATTENTION: For tables MIT06, MIT07, MIT08 conference tables with mediaboxes can be ordered as option. To order add a letter at the end of a product index: Mediabox S91E : Locations A,B (1pcs - extra charge 330,-), or C (2pcs - extra charge 660,-) | - Mediaport S92E: Locations G,H (1pcs - 500,-), or K (2pcs - 1000,-)

Mobile pedestal without handles (MIT120, MIT130)

- 1 **Top** - MFC 18 mm, ABS edge
- 2 **Body** - MFC 18 mm, ABS edge
- 3 **MFC drawer** - ball runners, max load 25kg, 100% extraction; Anti-tilt mechanism, soft closing
- 4 **Castors** - Ø50 mm, two with brakes
- 5 **Front** - MFC 18 mm, ABS edge
- 6 **Central lock** - foldable key
- 7 **Pencil tray** - plastic, colour: black
- 8 **Optional cushion SKP13** - for pedestal, max load 120 kg, ordered separately

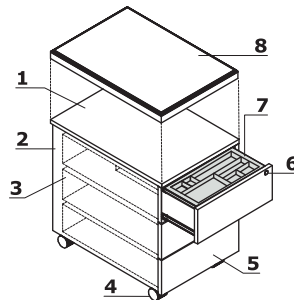

ATTENTION - sitting on the pedestal possible only after mounting the cushion (SKP13); the pedestal with cushion is intended for sitting only - moving the pedestal while sitting may result in damaging the castors

Mobile pedestal without handles (SLD12HT, SLD13HT)

- 1 **Top** - MFC 18 mm, coated with HPL high gloss
- 2 **Body** - MFC 18 mm, ABS edge
- 3 **Metal drawer** - roll runners, max load 25 kg, 80% extraction, anti-tilt mechanism; OPTION WITH EXTRA CHARGE - ball runners, soft-closing system
- 4 **Castors** - Ø50 mm, two with brakes
- 5 **Front** - MFC 18 mm, coated with HPL high gloss, ABS edge
- 6 **Central lock** - foldable key
- 7 **Pencil tray** - plastic, colour: black
- 8 **Optional cushion SKP13** - for pedestal, max load 120 kg, ordered separately
- 9 **Suspension files drawer** - ball runners, max load 30 kg, 100% extraction, A4 folders can be situated parallelly and perpendicularly to the front

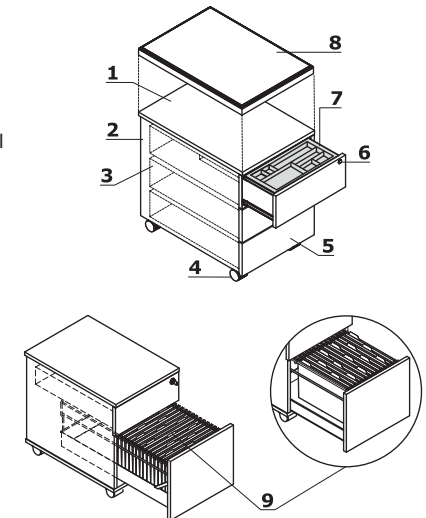

ATTENTION - sitting on the pedestal possible only after mounting the cushion (SKP13); the pedestal with cushion is intended for sitting only - moving the pedestal while sitting may result in damaging the castors

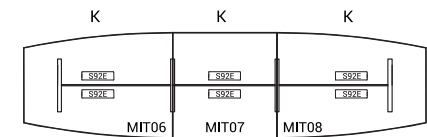
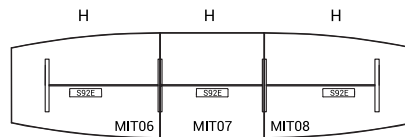
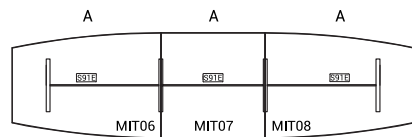
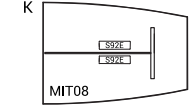
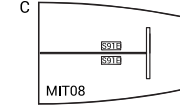
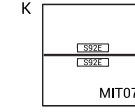
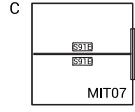
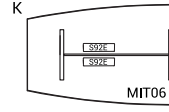
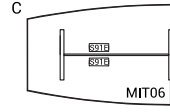
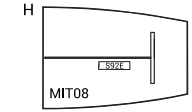
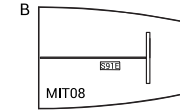
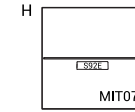
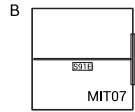
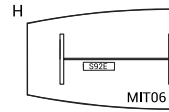
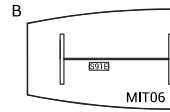
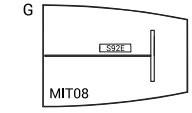
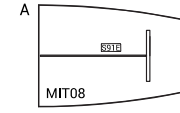
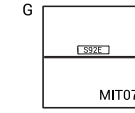
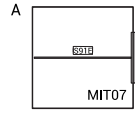
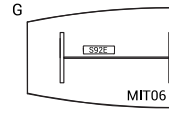
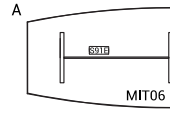

Possible mediaport location

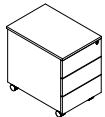
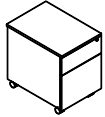
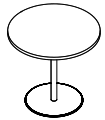
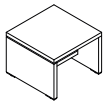
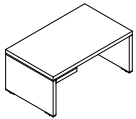
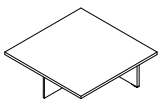
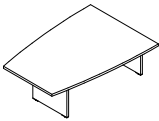

TO ORDER PRODUCT WITH MEDIABOX, AT THE END OF THE SYMBOL SHOULD BE ADDED A LETTER (A,B,...); WHICH IS CORRESPONDING TO THE SELECTED CONFIGURATION (EX. MIT06A); THE PRICE OF THE MEDIABOX SHOULD BE ADDED TO THE PRICE OF THE BASIC PRODUCT.

Mobile pedestal without handles							
	Symbol	Price RON with TVA	Dimensions			kg m3 pcs	Comments
			Width	Depth	Height		
	MIT130	1820,-	428	600	586	35 kg 0.154 m3 1 pcs	drawers depth - 500 mm, all in one colour
	SLD13HT	2236,-	416	600	587	23 kg 0.158 m3 1 pcs	drawers depth - 500 mm, front and top - HPL, all in one colour
	MIT120	1898,-	428	600	586	32 kg 0.154 m3 1 pcs	mobile with suspension files drawer, drawers depth - 500 mm, possibility of hanging up the files perpendicularly to the front, all in one colour
	SLD12HT	2340,-	416	600	587	23 kg 0.158 m3 1 pcs	mobile with suspension files drawer, drawers depth - 500 mm, front and top - HPL, all in one colour
Meeting tables							
	MIT10	3172,-	800	800	740	36 kg 0.107 m3 3 pcs	column Ø50 mm, disc Ø500 mm
	MIT17	3484,-	1200	1200	740	64 kg 0.15 m3 3 pcs	column Ø100 mm, disc Ø620 mm
	MIT23	3198,-	600	600	550	32 kg 0.078 m3 3 pcs	
	MIT9	3484,-	1000	600	450	33 kg 0.091 m3 3 pcs	
	MIT07	3640,-	1400	1400	740	67.4 kg 0.184 m3 4 pcs	middle element of conference table - mediaport location A, B,G,H (1qty); or C,K (2qty);
	MIT06	4654,-	2000	1000 1400	740	89.2 kg 0.275 m3 3 pcs	begining element of conference table - mediaport location A, B,G,H (1qty); or C,K (2qty);

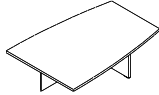
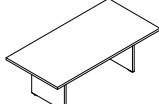
Extra charge RON with TVA							
Self closing system	Ball runners						
151,-	172,-						
151,-	57,-						

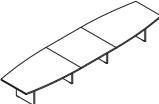
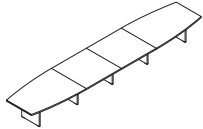
Meeting tables							
	Symbol	Price RON with TVA	Dimensions			kg m3 pcs	Comments
			Width	Depth	Height		
	MIT08	4264,-	2000	1000 1400	740	77.2 kg 0.252 m3 3 pcs	ending element of conference table – mediaport location A, B,G,H (1qty); or C,K (2qty);
	MIT11	5278,-	2200	1100	740	86.8 kg 0.252 m3 2 pcs	
Meeting tables - pre-defined configurations							
	MIT24	8892,-	4000	1000 1400	740	166.4 kg 0.527 m3 6 pcs	Composition elements: MIT06 + MIT08
	MIT25	12532,-	5400	1000 1400	740	233.8 kg 0.711 m3 10 pcs	Composition elements: MIT06 + MIT07 + MIT08
	MIT26	16172,-	6800	1000 1400	740	301.2 kg 0.895 m3 14 pcs	Composition elements: MIT06 + MIT07 x2 + MIT08

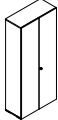
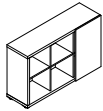
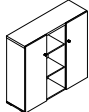
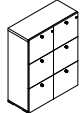

Extra charge RON with TVA							
Mediaport S91E x2	Mediaport S92E x2						
3640,-	5460,-						

Extra charge RON with TVA							

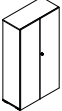
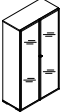
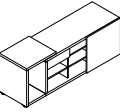
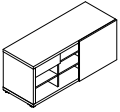

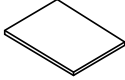
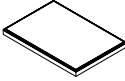

Storages with HPL front							
	Symbol	Price EUR	Dimensions			kg m3 pcs	Comments
			Width	Depth	Height		
	MIT21	3042,-	916	418	879	49 kg 0.117 m3 1 pcs	
	MIT19	4914,-	916	418	2077	98 kg 0.266 m3 3 pcs	5 shelves
	MIT18	3822,-	1400	422	879	72 kg 0.186 m3 3 pcs	sliding door
	MIT7	4420,-	1400	422	1280	97 kg 0.226 m3 4 pcs	
	MIT20	4212,-	1363	418	1280	89 kg 0.213 m3 3 pcs	
	MIT22	8502,-	980	418	1280	87 kg 0.572 m3 1 pcs	file drawers



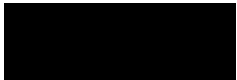

Storages							
	Symbol	Price RON with TVA	Dimensions			kg m3 pcs	Comments
			Width	Depth	Height		
	MIT8	3692,-	916	418	1661	74.6 kg 0.151 m3 2 pcs	wardrobe/storage cabinet with slide-out hanger
	MIT15	3588,-	916	418	1661	79.3 kg 0.229 m3 2 pcs	4 shelves
	MIT16	4914,-	916	418	1661	82.5 kg 0.242 m3 3 pcs	doors with transparent tempered glass and aluminium frame
	MIT5	5876,-	1887	572	690	118.6 kg 0.301 m3 9 pcs	storage with HPL extension, drawer with lock, sliding door; the extension unit can be mounted on the either side of the cabinet
	MIT6	5304,-	1500	572	652	94.6 kg 0.253 m3 5 pcs	drawer with lock, sliding door



Extra charge RON with TVA							
Mediaport S91E							
1820,-							
1820,-							









Accessories							
	Symbol	Price RON with TVA	Dimensions			kg m3 pcs	Comments
			Width	Depth	Height		
	S100	1170,-	416	600	5	0 kg 0 m3 0 pcs	desk pad - black leather
	SKP13	4056,-	400	600	52	3 kg 0.017 m3 1 pcs	pedestal cushion
	S91E	1820,-	267	110	93	1 kg 0.01 m3 1 pcs	mediaport 2 x 230V, 2 x RJ45
	S92E	2730,-	426	110	93	1 kg 0.014 m3 1 pcs	mediaport 4 x 230V, 4 x RJ45



Extra charge RON with TVA							
II Price group	III Price group	IV price group					
57,-	135,-	192,-					

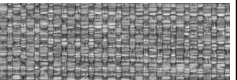

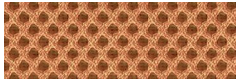
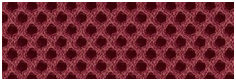
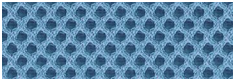
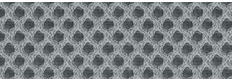
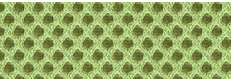
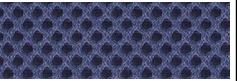
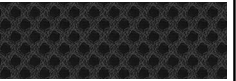
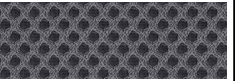

MFC							
 08 - black	 67 - white pastel						
 172 - amber oak	 173 - robinia						

Metal				
 M009 - aluminium semi-matt RAL 9006	 M015 - white semi-matt RAL 9010	 M154 - anthracite semi-matt RAL 7043	 154 - anthracite	

HPL							
 73 - white high gloss	 101 - black high gloss	 155 - anthracite high gloss					

Fabric Nemo - first price group							
 NE-1 - beige	 NE-2 - yellow	 NE-3 - orange	 NE-5 - red	 NE-9 - green	 NE-10 - grey	 NE-14 - graphite	 NE-15 - navy blue
 NE-16 - black	 NE-17 - blue						

Fabric Runner - second price group							
 R-63034 - orange	 R-64089 - red	 R-66063 - blue	 R-60011 - grey	 R-68056 - green	 R-66064 - navy blue	 R-60999 - black	 R-60025 - graphite
 R-61128 - beige	 R-61130 - brown						

Fabric Medley - second price group							
 M-68005 - dark olive	 M-68002 - light olive	 M-68115 - green	 M-61002 - beige	 M-67053 - dark blue	 M-67006 - light blue	 M-66008 - grey	 M-64019 - red
 M-63064 - pink	 M-60999 - black						

Fabric Atlantic - second price group (Remaining Atlantic colours, as per Gabriel's pattern book, available within 8 weeks)							
 A-67043 - dark turquoise	 A-67030 - aquamarine	 A-60141 - light grey	 A-60011 - grey	 A-66064 - navy blue	 A-65037 - violet	 A-62048 - olive	 A-64089 - red
 A-61078 - beige	 A-60025 - graphite						

Fabric River - second price group

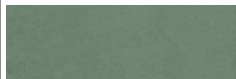
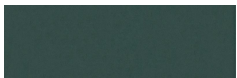
 RV21 - beige	 RV24 - light brown	 RV28 - dark brown	 RV34 - green grey	 RV38 - dark green	 RV41 - mustard	 RV51 - orange	 RV79 - navy blue
 RV87 - aquamarine	 RV91 - grey	 RV100 - black					









Fabric Synergy - third price group

 LDS08 - grey melange	 LDS20 - light grey	 LDS27 - black	 LDS29 - dark grey	 LDS50 - dark green	 LDS53 - green	 LDS57 - turquoise	 LDS60 - bottle green
 LDS61 - plum	 LDS69 - navy blue	 LDS84 - orange	 LDS86 - red	 LDS88 - aubergine	 LDS85 - coral	 LDS19 - beige	 LDS44 - yellow
 LDS79 - brown							

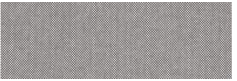
Fabric Xtreme - third price group

 XR160 - aquamarine	 XR430 - dark turquoise	 XR026 - navy blue	 XR084 - violet	 XR009 - black	 XR420 - olive	 XR081 - dark grey	 XR094 - grey
 XR108 - beige	 XR079 - red	 YS071 - light brown					

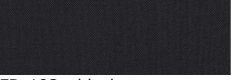
Fabric Atlas - fourth price group							
							
AS-531 - orange	AS-501 - pink	AS-651 - red	AS-681 - burgundy	AS-391 - brown	AS-781 - navy blue	AS-161 - dark grey	AS-111 - light grey
							
AS-971 - light green	AS-981 - dark green						

Fabric Field2 - fourth price group							
							
FD-463 - yellow	FD-963 - green	FD-123 - beige	FD-132 - grey	FD-142 - graphite	FD-662 - red	FD-782 - navy blue	FD-693 - burgundy
							
FD-192 - black	FD-673 - blue-red						