

Walls as you've never
touched before

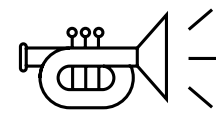

The Idea



Acoustics

All products effectively absorb sound, the secret lies in the open-cell structure of the material they are made of. The soundproofing properties of the panels were tested at the accredited acoustic laboratory of the Marine Technology Institute.

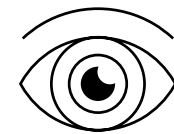

Design

Products means elegant and creative design, giving the interior a new unique style. It is a design masterpiece – just a few panels will transform the entire interior.

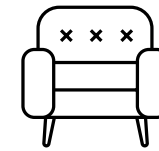

Cosiness

New interior design idea, where cosiness plays the key role. All products are covered with a soft finish, made up of millions of colourful polyamide microfibers glued to the surface; they are sensuous and velvety to the touch.

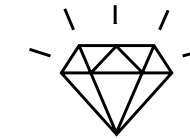

Quality

All our team consists of experienced specialists who select the best materials, and assure that our products possess the best properties as far as safety, durability and precision are concerned. We are the best – inimitable!

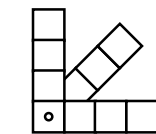

Variety

Panele Fluffo tworzymy w wielu różnych kształtach, rozmiarach i kolorach. Nadajemy im funkcję dekoracyjną i akustyczną. Oprócz licznych wzorów oferujemy kilkadziesiąt autorskich kolorów. Daje to wręcz nieograniczone możliwości kombinacji i tworzenia oryginalnych aranżacji.

Fluffo panels come in many complex shapes, sizes and colours. They have both decorative and acoustic applications. The numerous models, and few dozen available colours give the freedom to create any combination - possibilities are endless.

smart interior design

FOR YOUR OFFICE

WWW.SMARTINTERIOR.RO

Strada Ziduri Intre Vii, Nr 19, Corp A, Sector 2, Bucuresti.
Email: office@smartinterior.ro
tel: 0742220325 / 0733626222

Sound absorption. When there is an reverberation.

All products have acoustic properties characterised by a high sound absorption coefficient. They work perfectly in spaces, which require an improvement of overall interior acoustics: there is a problem with echoes, reverberation or noise. In other words a problem with bothersome sound created within a room. Our experience shows that covering as little as 20 to 40% of walls with panels will work wonders within a room with a reverberation problem. The echoes are reduced and the room becomes cosy and quiet.

products dedicated to absorb sound:

- SOFT,
- FIRE RESIST,
- GLASS,
- ART,
- WEB,
- AIR.

The acoustic properties of our products were tested in an accredited research institute.

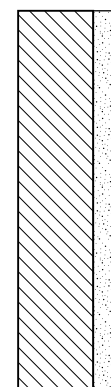

Panel **SOFT**

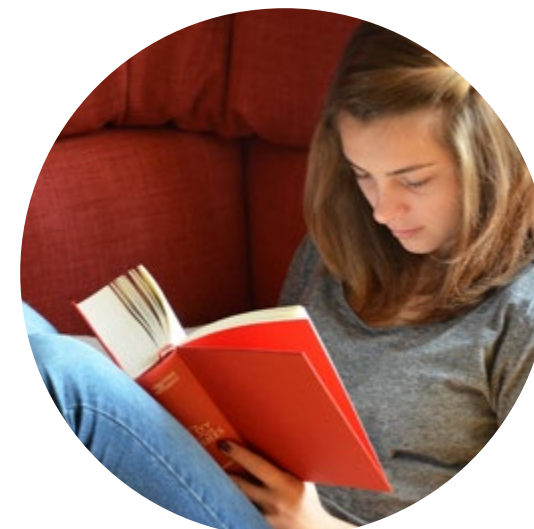

Panel **IZO**

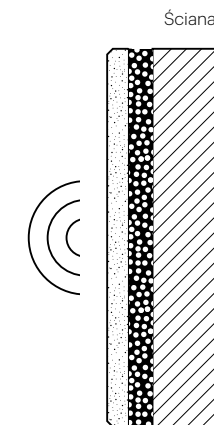

Sound insulation When you hear your neighbour

When there is a problem with outside noise penetrating the walls (noisy neighbour, rowdy office kitchenette next to your office) IZO: specially designed, multilayer, decorative, sound insulating wall panels, will be the answer.

IZO is the alternative to the classic solution – considerable refurbishment, mess and commotion with the installation of an insulating wall constructed from plaster board, insulation membrane and mineral wool; finished with filling, sanding and painting.

product dedicated to sound insulation:

- IZO



Choose the best solution to fit your needs

smart interior design

FOR YOUR OFFICE

WWW.SMARTINTERIOR.RO

Strada Ziduri Intre Vii, Nr 19, Corp A, Sector 2,
Bucuresti. Email: office@smartinterior.ro
tel: 0742220325 / 0733626222

7 collections, to aid the
creation of a beautiful and
functional interior

product		firmness	(acoustic properties)	available thicknesses	number of colours	installation	(edge)	
SOFT	3D	o 3D panels	(soft)	(sound absorption) 0,80*	from 20 mm to 50 mm	56	(with use of adhesive)	straight
	Flat	flat panels	(soft)	(sound absorption) 0,80*	20, 30, 40, 50 mm	56	(with use of adhesive)	(straight, bevelled on request)
	EDGE	lat panels with bevelled edge	(soft)	(sound absorption) 0,80*	30 mm	56	(with use of adhesive)	bevelled
	RIFT	flat panels with corrugated surface	(soft)	(sound absorption) 0,80*	30 mm	56	(with use of adhesive)	predifined straight and bevelled
IZO	sound insulation panels	(soft)	sound insulation Rw (C,Ctr) = 27 (0,-2) dB	62 mm	56	(with use of adhesive)	bevelled	
FIRE RESIST	fire retardant office wall panels	(firm)	sound absorption 0,55*	20, 30 mm	56	(with use of adhesive)	straight	
WEB	acoustic curtains	(soft)	sound absorption 0,80*	40 mm	56 + 56, possible varied colour of each side	(rail under the ceiling)	(bevelled on both sides)	
ART	arge-format wall panels	(soft)	Pochłania dźwięk (sound absorption) 0,80*	56 mm	56, MDF (bottom MDF board in black)	(with use of mounting clips)	bevelled	
AIR	overhead elements	(firm)	(sound absorption) 0,60*	40 mm	56	(ceiling mounting with steel wires)	straight	
GLASS	glass surface panels	(soft)	(sound absorption) 0,80*	36 mm	56 + 56 possible varied colours of each side	(with use of suction cups)	(bevelled on request)	

* In accordance with the research conducted by the accredited acoustic laboratory of the Ship Technology Institute.

** In accordance with the research conducted by the producer of the materials used for manufacturing .



SOFT

Soft wall panels



IZO

Sound insulation panels



FIRE-RESIST

Fire retardant office wall panels



AIR

Overhead elements

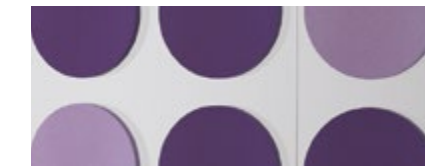

GLASS

Glass surface panels



WEB

Acoustic curtains

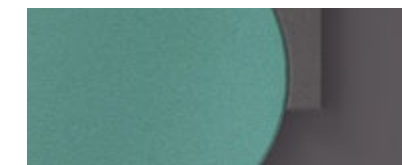

ART

Large-format wall panels

smart interior design

FOR YOUR OFFICE

WWW.SMARTINTERIOR.RO

Strada Ziduri Intre Vii, Nr 19, Corp A, Sector 2,
Bucuresti. Email: office@smartinterior.ro
tel: 0742220325 / 0733626222

All collections share the same characteristics:
elegant design and excellent sound absorption
properties.

Our products are available in many complex
shapes, sizes and colours. Velvety finish is soft
and sensuous to the touch creating a
comfortable and discreet mood in the interior.

Go on, cuddle up!

The Colours

Not just the shape or softness. It is also the colour, which introduces the desired ambience to the interior, adds positive energy and stimulates creativity. Reflects current design and fashion trends and accentuates our lifestyle.

Pixel S



smart interior design
FOR YOUR OFFICE
WWW.SMARTINTERIOR.RO

Strada Ziduri Intre Vii, Nr 19, Corp A, Sector 2,
Bucuresti. Email: office@smartinterior.ro
tel: 0742220325 / 0733626222

Choose the colour that fits you

smart interior design
FOR YOUR OFFICE
WWW.SMARTINTERIOR.RO

Strada Ziduri Intre Vii, Nr 19, Corp A, Sector 2,
Bucuresti. Email: office@smartinterior.ro
tel: 0742220325 / 0733626222

palette consist of 56 original colours, you are free to create any combination, possibilities are endless.



The Finish

All products are covered with a soft finish, made up of millions of colourful polyamide microfibers glued to the surface; they are sensuous and velvety to the touch.

Photo of the magnified finish. The length of a single fibre is 1 mm.

smart interior design
FOR YOUR OFFICE
WWW.SMARTINTERIOR.RO

Strada Ziduri Intre Vii, Nr 19, Corp A, Sector 2,
Bucuresti. Email: office@smartinterior.ro
tel: 0742220325 / 0733626222

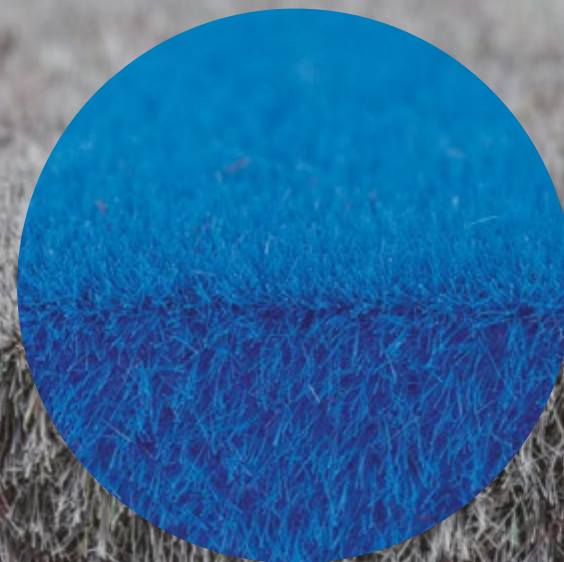
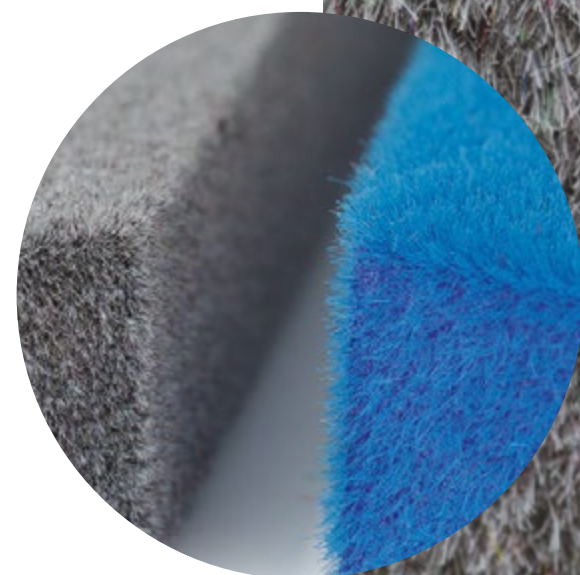

Our favourite colour sets

Our favourite colour sets. Experience how colours express emotions, feelings and moods. Get inspired by our sample colour sets and create your own magical world.



smart interior design
FOR YOUR OFFICE
WWW.SMARTINTERIOR.RO

Strada Ziduri Intre Vii, Nr 19, Corp A, Sector 2,
Bucuresti. Email: office@smartinterior.ro
tel: 0742220325 / 0733626222

„Joy” sample colour combination



Soft wall panels

- 3D panels
- Flat panels
- Flat panels with bevelled edge
- Flat panels with corugated surface

Fluffo SOFT is a collection of decorative, soundproofing wall panels, available in a wide selection of colours, shapes and thicknesses. They soundproof a room in a beautiful and stylish way. With Fluffo SOFT you can enjoy a cosy, quiet and most importantly, beautiful interior. Go on, get to work!

smart interior design
FOR YOUR OFFICE
WWW.SMARTINTERIOR.RO

Strada Ziduri Intre Vii, Nr 19, Corp A, Sector 2,
Bucuresti. Email: office@smartinterior.ro
tel: 0742220325 / 0733626222



Material

1. finish
2. Polyurethane foam

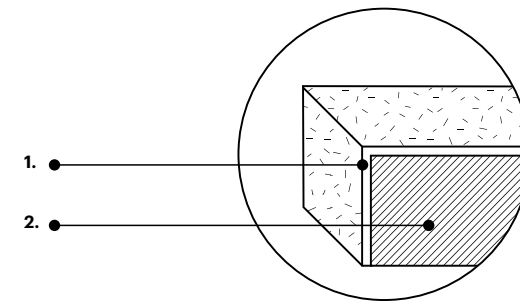

Acoustics

α_s Sound absorption coefficient according to PN-EN ISO 354:2005

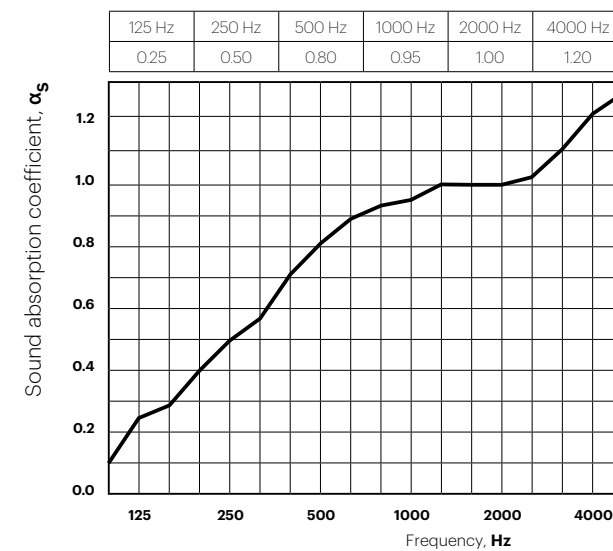

Sound absorption indicator according to PN-EN ISO 11654:1997
 $\alpha_w = 0,80$

Sound absorption class: B



SOFT 3D

3D panels

smart interior design

FOR YOUR OFFICE

WWW.SMARTINTERIOR.RO

Strada Ziduri Intre Vii, Nr 19, Corp A, Sector 2,
Bucuresti. Email: office@smartinterior.ro
tel: 0742220325 / 0733626222

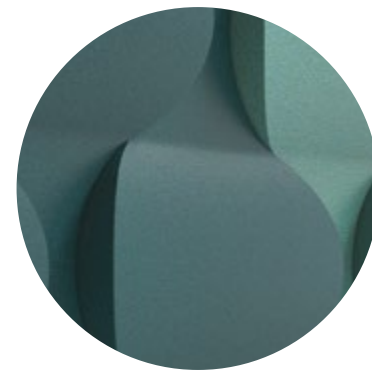

3D



soft

SOFT 3D / Flow



Chevron



Thickness : 2 - 5 cm
Weight : 140 g
1 pc = 0,10 m²
10 pcs = 1,01 m²

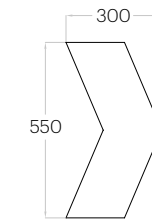

Chain



Thickness : 2 - 5 cm
Weight : 190 g
1 pc = 0,13 m²
7 pcs = 0,94 m²

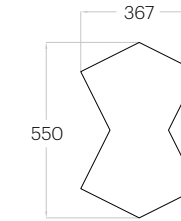

Flow



Thickness : 2 - 5 cm
Weight : 150 g
1 pc = 0,11 m²
9 pcs = 0,97 m²

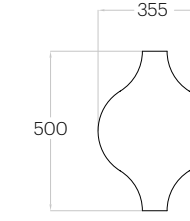

SOFT 3D / Chain



Link



Thickness : 2 - 5 cm
Weight : 240 g
1 pc = 0,18 m²
6 pcs = 1,05 m²

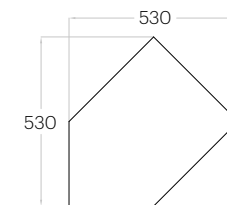

Cube



Thickness : 2 - 5 cm
Weight : 350 g
1 pc = 0,25 m²
4 pcs = 1,00 m²

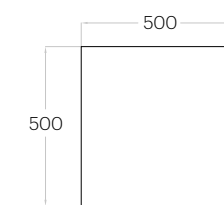

Cubic

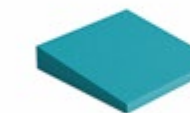

Thickness : 2 - 5 cm
Weight : 90 g
1 pc = 0,06 m²
16 pcs = 1,00 m²

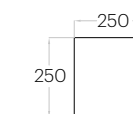

SOFT

Flat panels

smart interior design

FOR YOUR OFFICE

WWW.SMARTINTERIOR.RO

Strada Ziduri Intre Vii, Nr 19, Corp A, Sector 2,
Bucuresti. Email: office@smartinterior.ro
tel: 0742220325 / 0733626222

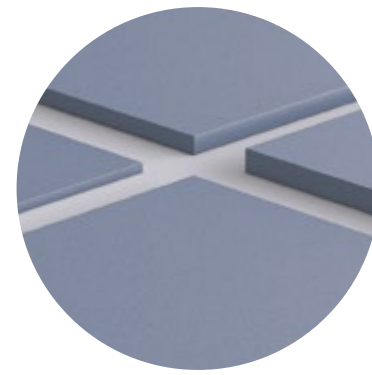

4 thicknesses: 2 / 3 / 4 / 5 cm



soft

SOFT / Tele L, Tele S



Pixel L



Thickness : 20/30/40/50 mm
Weight : 240/310/380/440 g
1 pc = 0,25 m²
4 pcs = 1,00 m²

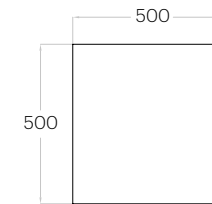

Pixel M



Thickness : 20/30/40/50 mm
Weight : 140/170/210/250 g
1 pc = 0,14 m²
7 pcs = 0,98 m²

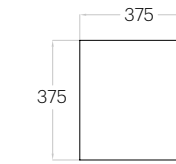

Pixel S



Thickness : 20/30/40/50 mm
Weight : 60/80/90/110 g
1 pc = 0,06 m²
16 pcs = 1,00 m²

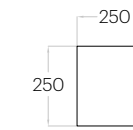

Hexa L



Thickness : 20/30/40/50 mm
Weight : 240/300/370/440 g
1 pc : 0,16 m²
6 pcs : 0,97 m²

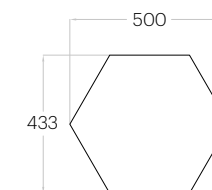

Hexa M



Thickness : 20/30/40/50 mm
Weight : 130/170/210/240 g
1 pc : 0,10 m²
10 pcs : 1,04 m²

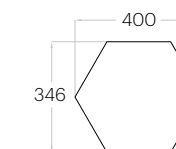

Hexa S



Thickness : 20/30/40/50 mm
Weight : 60/70/90/100 g
1 pc : 0,04 m²
24 pcs : 0,97 m²

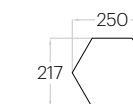

SOFT / Hexa L





Tele L

Thickness : 20/30/40/50 mm
 Weight : 240/300/370/440 g
 1 pc ~ 0,25 m²
 4 pcs ~ 1,00 m²

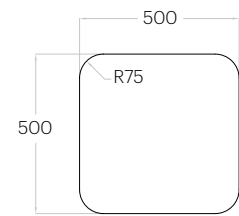

Tele M

Thickness : 20/30/40/50 mm
 Weight : 130/170/210/240 g
 1 pc ~ 0,14 m²
 7 pcs ~ 0,98 m²

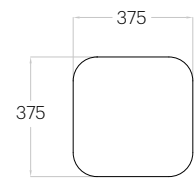

Tele S

Thickness : 20/30/40/50 mm
 Weight : 60/70/90/100 g
 1 pc ~ 0,06 m²
 16 pcs ~ 1,00 m²

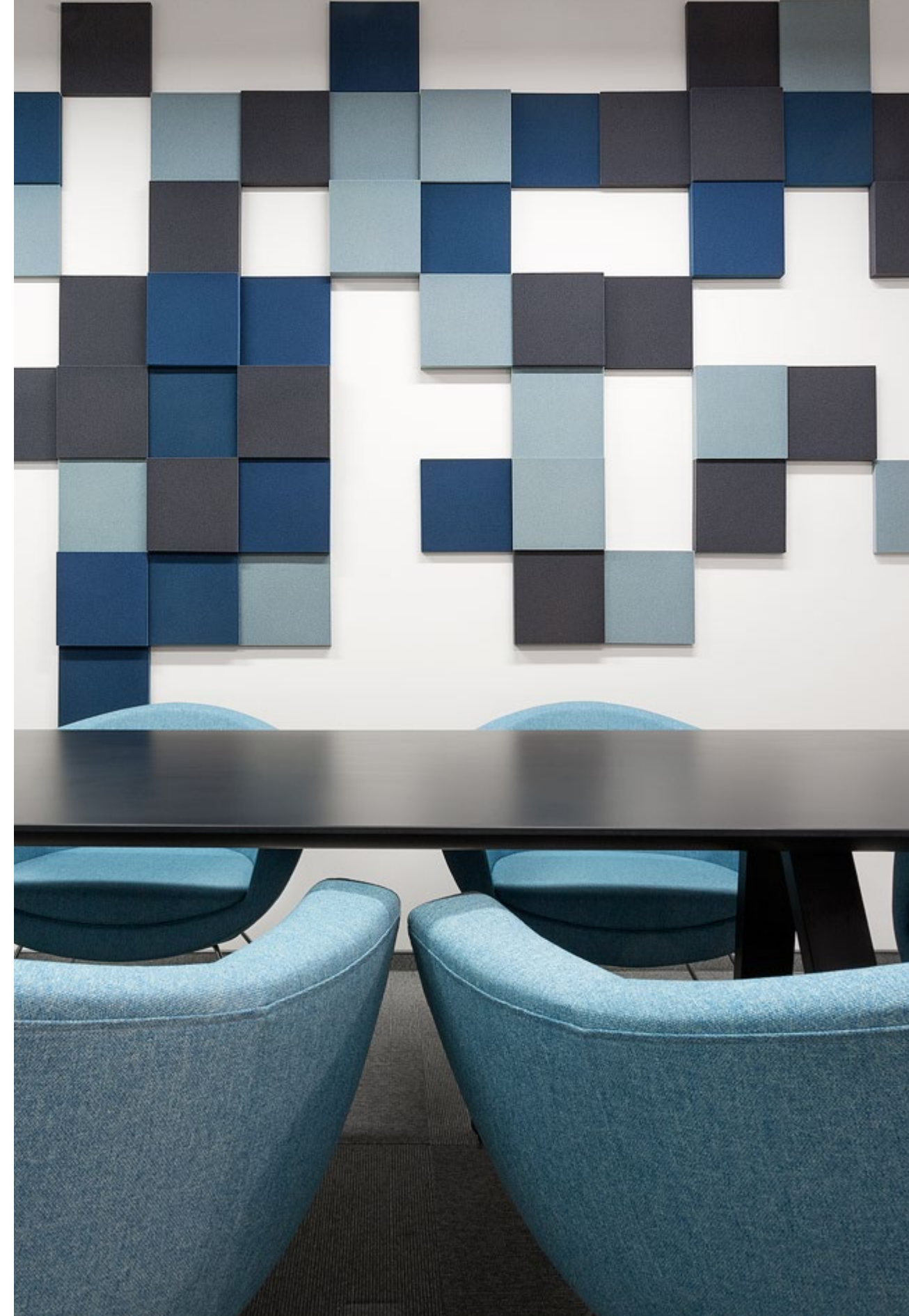
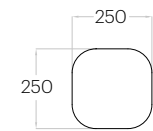

SOFT / Pixel M



Dot L

Thickness : 20/30/40/50 mm
 Weight : 190/240/300/350 g
 1 pc : 0,20 m²
 5 pcs : 0,98 m²

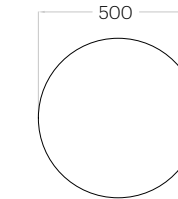

Dot M

Thickness : 20/30/40/50 mm
 Weight : 80/110/130/150 g
 1 pc : 0,09 m²
 12 pcs : 1,03 m²

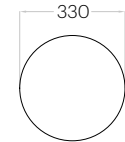

Tele Cut L *



Thickness : 20/30/40/50 mm
 Weight : 180/230/280/340 g
 1 pc : 0,19 m²
 5 pcs : 0,93 m²

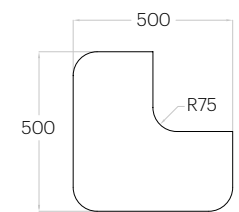

Tele Cut M *



Thickness : 20/30/40/50 mm
 Weight : 100/130/160/180 g
 1 pc : 0,10 m²
 10 pcs : 1,03 m²

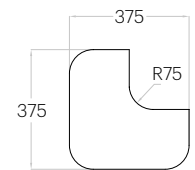

Tele Cut S *



Thickness : 20/30/40/50 mm
 Weight : 50/60/70/80 g
 1 pc : 0,04 m²
 22 pcs : 0,98 m²

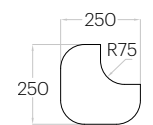

Line



Thickness : 20/30/40/50 mm
 Weight : 120/160/190/220 g
 1 pc : 0,13 m²
 8 pcs : 1,00 m²

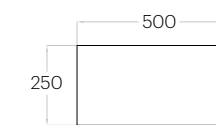

Triada



Thickness : 20/30/40/50 mm
 Weight : 60/80/90/110 g
 1 pc : 0,06 m²
 16 pcs : 0,97 m²

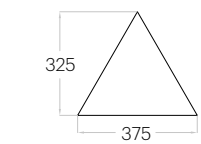

SOFT EDGE

Flat panels with bevelled edge

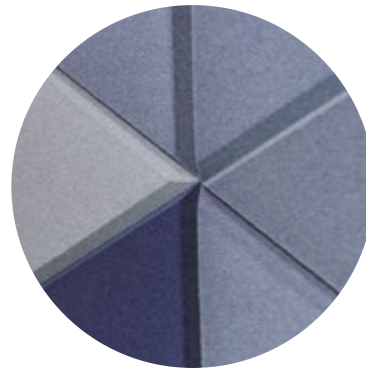

bevelled edge



soft

SOFT EDGE / Diamond Edge

smart interior design
FOR YOUR OFFICE
WWW.SMARTINTERIOR.RO

Strada Ziduri Intre Vii, Nr 19, Corp A, Sector 2,
Bucuresti. Email: office@smartinterior.ro
tel: 0742220325 / 0733626222



Pixel L Edge

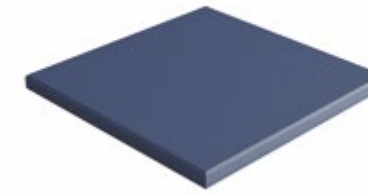

Thickness : 30 mm
Weight : 310 g
1 pc = 0,25 m²
4 Pcs = 1,00 m²

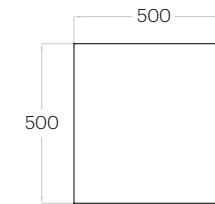

Pixel M Edge

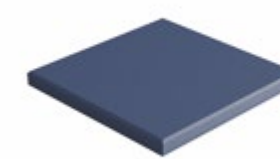

Thickness : 30 mm
Weight : 170 g
1 pc = 0,14 m²
7 Pcs = 0,98 m²

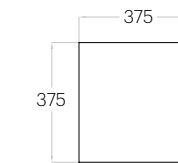

Pixel S Edge

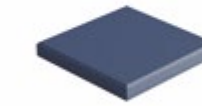

Thickness : 30 mm
Weight : 80 g
1 pc = 0,06 m²
16 pcs : 1,00 m²

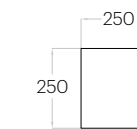

Dot M Edge



Thickness : 30 mm
Weight : 110 g
1 pc = 0,09 m²
12 pcs = 1,03 m²

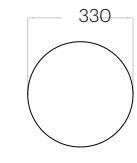

Tele M Edge



Grubość (thickness): 30 mm
Waga (weight): 80 g
1 szt. (pc) : 0,06 m²
16 szt. (pcs) : 1,00 m²

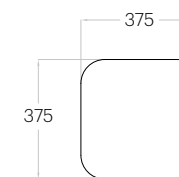

Hexa M Edge



Thickness : 30 mm
Weight : 130 g
1 pc = 0,10 m²
10 pcs = 1,04 m²

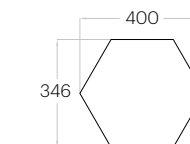

Octa Edge



Thickness : 30 mm
Weight : 380 g
1 pc. : 0,30 m²
3 pcs : 0,91 m²

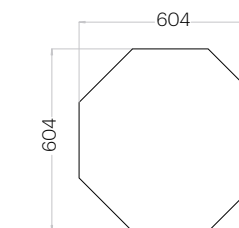

Triada Edge



Thickness : 30 mm
Weight : 170 g
1 pc = 0,14 m²
7 pcs = 0,98 m²

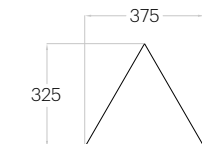

Echo L Edge



Thickness : 30 mm
Weight : 250 g
1 pc : 0,20 m²
5 pcs : 1,00 m²

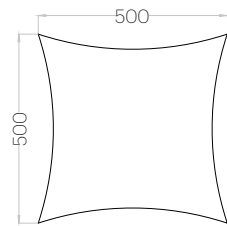

Echo M Edge



Thickness : 30 mm
Weight : 140 g
1 pc : 0,11 m²
9 pcs : 0,99 m²

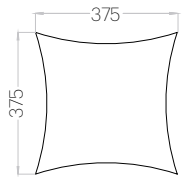

Echo S Edge



Thickness : 30 mm
Weight : 60 g
1 pc : 0,05 m²
20 pcs : 1,00 m²

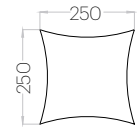

Hello L Edge



Thickness : 30 mm
Weight : 380 g
1 pc : 0,30 m²
3 pcs : 0,90 m²

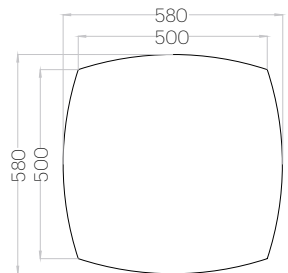

Hello M Edge



Thickness : 30 mm
Weight : 210 g
1 pc = 0,17 m²
5 szt. (pcs) = 0,85 m²

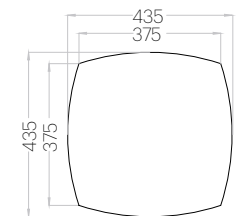

Hello S Edge



Thickness : 30 mm
Weight : 90 g
1 pc = 0,08 m²
12 pcs = 0,96 m²

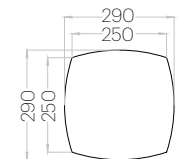

Stick Edge

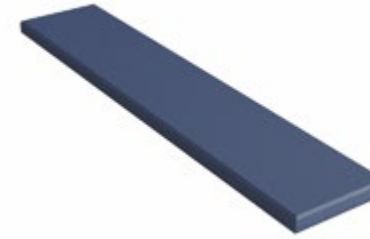

Thickness : 30 mm
Weight : 250 g
1 pc = 0,20 m²
5 pcs = 1,00 m²

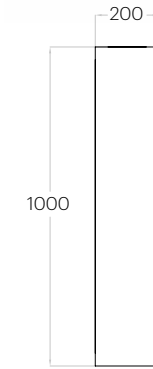

Diamond Edge



Thickness : 30 mm
Weight : 70 g
1 pc = 0,05 m²
18 pcs = 0,97 m²

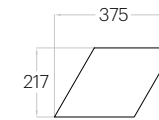

Line Edge

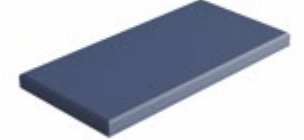

Thickness : 30 mm
Weight : 310 g
1 pc = 0,25 m²
4 pcs = 1,00 m²

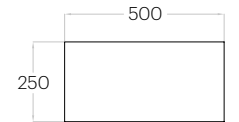

Bond Edge



Thickness : 30 mm
Weight : 210 g
1 pc : 0,16 m²
6 pcs : 0,96 m²

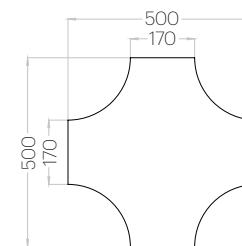

Shell Edge



Thickness : 30 mm
Weight : 110 g
1 pc. : 0,09 m²
11 pcs : 0,99 m²

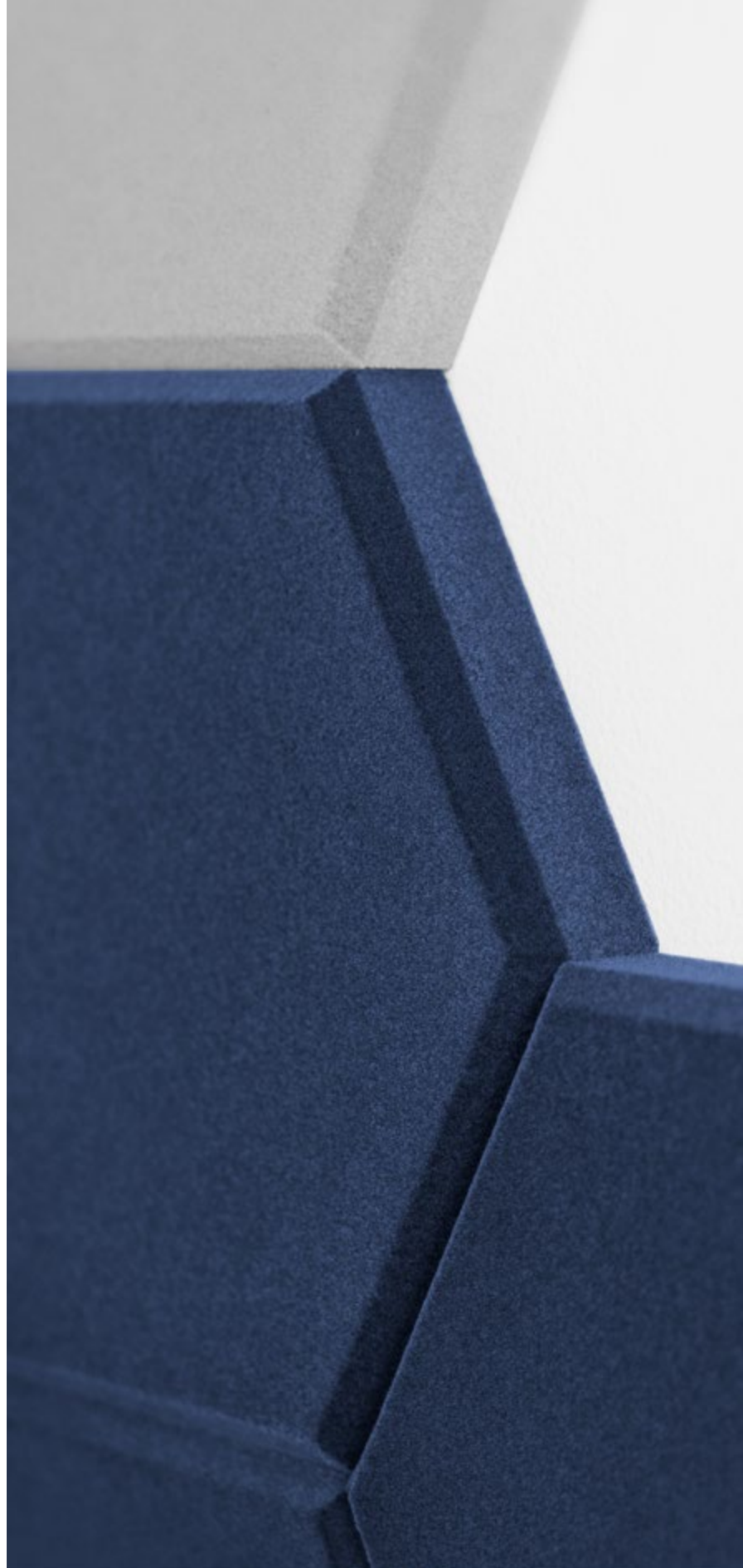
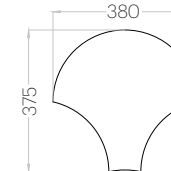

SOFT EDGE / Hexa M Edge

smart interior design

FOR YOUR OFFICE

WWW.SMARTINTERIOR.RO

Strada Ziduri Intre Vii, Nr 19, Corp A, Sector 2,
Bucuresti. Email: office@smartinterior.ro
tel: 0742220325 / 0733626222

RIFT

Flat panels with corrugated surface



corrugated surface



soft

smart interior design
FOR YOUR OFFICE
WWW.SMARTINTERIOR.RO

Strada Ziduri Intre Vii, Nr 19, Corp A, Sector 2,
Bucuresti. Email: office@smartinterior.ro
tel: 0742220325 / 0733626222



SOFT RIFT / Pixel L, Pixel L SemiRift, Pixel L Rift



Pixel L SemiRift

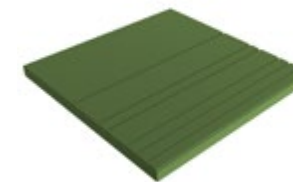

Thickness : 30 mm
Weight : 300 g
1 pc = 0,25 m²
4 pcs = 1,00 m²

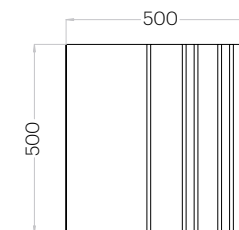

Pixel L Rift



Thickness : 30 mm
Weight : 290 g
1 pc = 0,25 m²
4 pcs = 1,00 m²

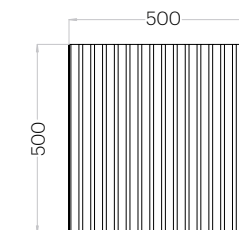

Grand Rift



Thickness : 30 mm
Weight : 290 g
1 pc : 0,25 m²
4 pcs : 1,00 m²

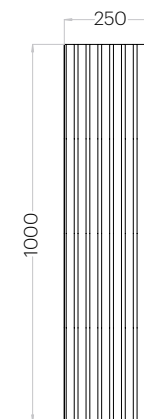

IZO

Sound insulation panels

IZO will decorate the interior and at the same time insulate the room from exterior sound sources. Panels built from layers of specially selected materials absorb sound and constitute a sound barrier, which works both ways: they don't let the sound in or out of the room. They are an ideal solution when you have a loud neighbour behind a thin wall, a dividing wall transmits sound between two offices, or you want to hold a private conference, or you want your secrets to stay within your four walls.

smart interior design

FOR YOUR OFFICE

WWW.SMARTINTERIOR.RO

Strada Ziduri Intre Vii, Nr 19, Corp A, Sector 2,
Bucuresti. Email: office@smartinterior.ro
tel: 0742220325 / 0733626222



Material

1. Fluffo finish
2. Sound absorbent polyurethane foam
3. High density rubber

4. Layer of open-cell flexible, foamed rubber

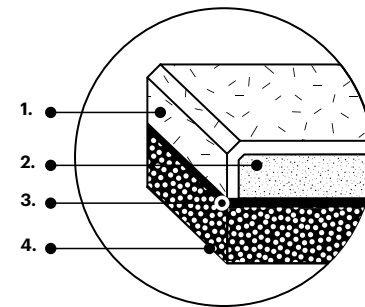

Acoustics

R_w Sound insulation according to ISO 140-3

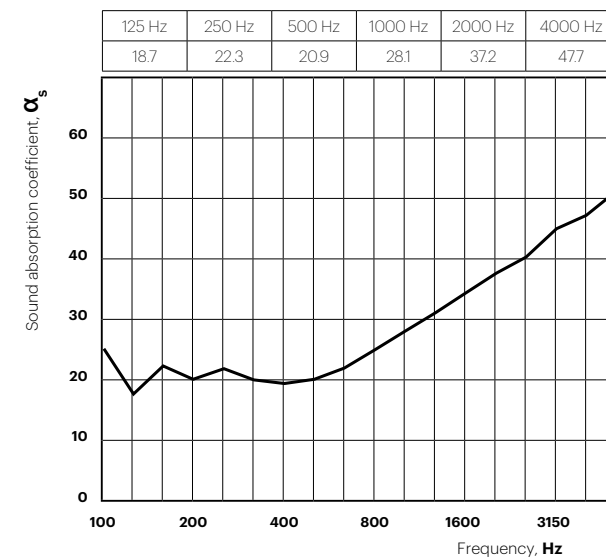

Sound insulation according to ISO 140-3* **R_w (C;Ctr) = 27 (0;-2) dB**

*Research carried out by the base material producer according to ISO 140-3 and ISO 717-1 norms.



Hexa Edge M



Thickness : 62 mm
Weight : 990 g
1 pc : 0,1 m²
10 pcs : 1,04 m²

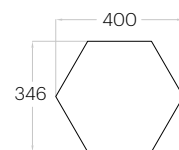

Octa Edge



Thickness : 62 mm
Weight : 2900 g
1 pc : 0,30 m²
3 pcs : 0,91 m²

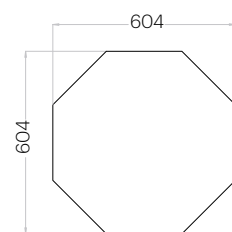

Line Edge

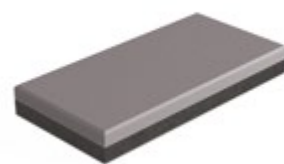

Thickness : 62 mm
Weight : 1190 g
1 pc : 0,13 m²
8 pcs : 1,00 m²

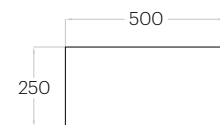

Pixel L Edge

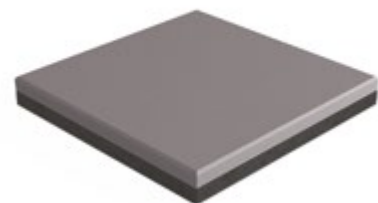

Thickness : 62 mm
Weight : 2380 g
1 pc : 0,25 m²
4 Pcs : 1,00 m²

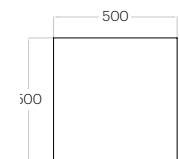

Pixel M Edge

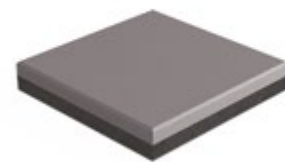

Thickness : 62 mm
Weight : 1340 g
1 pc : 0,14 m²
7 pcs : 0,98 m²

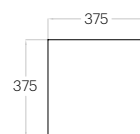

Pixel S Edge

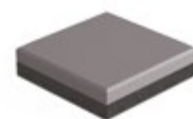

Thickness : 62 mm
Weight : 590 g
1 pc : 0,06 m²
16 pcs : 1,00 m²

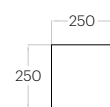

IZO in details.

Izo is built of 3 layers: first is the Soft panel, covered with the finish. Underneath there are two rubber layers made of high density and foamed rubber. The whole constitutes an effective sound insulating material.

smart interior design

FOR YOUR OFFICE

WWW.SMARTINTERIOR.RO

Strada Ziduri Intre Vii, Nr 19, Corp A, Sector 2,
Bucuresti. Email: office@smartinterior.ro
tel: 0742220325 / 0733626222



Panel IZO - structure

IZO / Pixel S Edge

FIRE-RESIST

Fire retardant office wall panels

FIRE-RESIST wall panels are intended for public spaces, where finishing materials must comply with the fire prevention standards PN-EN 135011 + A1: 2010. Fire retardant, acoustic wall panels are available in many shapes, colours and two thicknesses, allowing the creation of unique, 3D compositions. They will work perfectly in offices, conference rooms and office telephone booths, creating safe and functional work space.

smart interior design
FOR YOUR OFFICE
WWW.SMARTINTERIOR.RO

Strada Ziduri Intre Vii, Nr 19, Corp A, Sector 2,
Bucuresti. Email: office@smartinterior.ro
tel: 0742220325 / 0733626222



Material

1. Fluffo finish
2. High density bio-soluble mineral wool

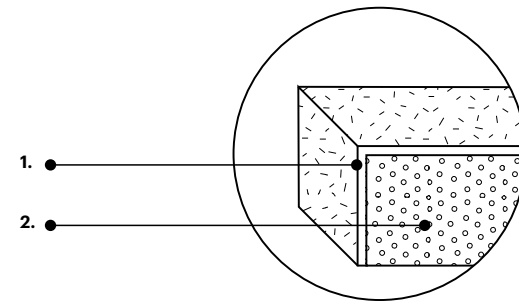

Acoustics

α_s Sound absorption coefficient according to PN-EN ISO 354:2005

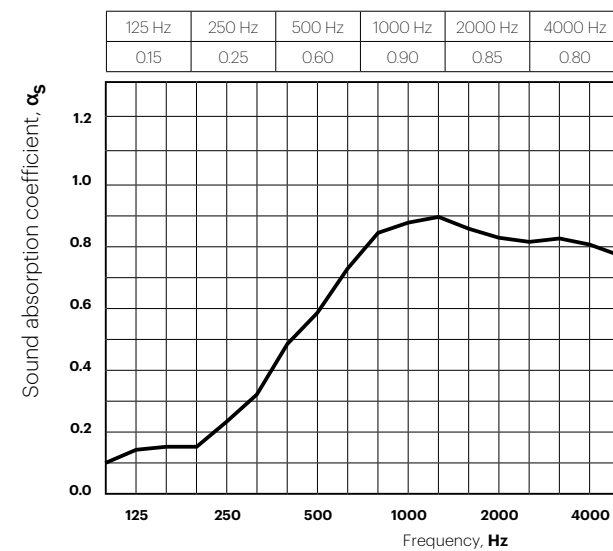

Sound absorption indicator according to PN-EN ISO 11654:1997 $\alpha_w = 0,55$

Sound absorption class: D





classification of fire resistance
PN-EN 135011+A1:2010 D-s1 d0
Fire Retardant,
non-dripping.

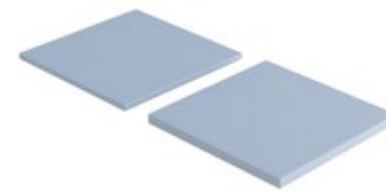

Pixel L

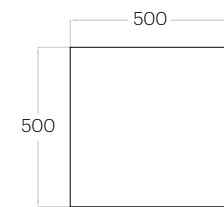

Thickness : 20/30 mm
 Weight : 1150/2 680 g
 1 pc : 0,25 m²
 4 pcs : 1,00 m²



Pixel M



Thickness : 20/30 mm
 Weight : 650/1500 g
 1 pc : 0,14 m²
 7 pcs : 0,98 m²

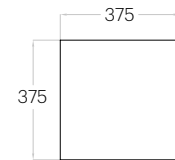

Pixel S

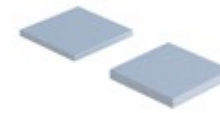

Thickness : 20/30 mm
 Weight : 290/670 g
 1 pc : 0,06 m²
 16 pcs : 1,00 m²

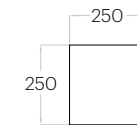

Tele L



Thickness : 20/30 mm
 Weight : 1130/2 620 g
 1 pc : 0,25 m²
 4 pcs : 0,98 m²

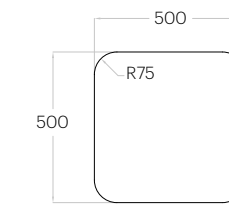

Tele M



Thickness : 20/30 mm
 Weight : 620/1450 g
 1 pc = 0,14 m²
 7 pcs = 0,95 m²

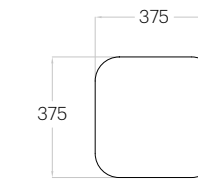

Tele S



Thickness : 20/30 mm
 Weight : 270/620 g
 1 pc = 0,06 m²
 16 pcs = 0,98 m²

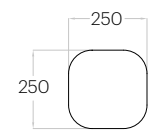

Hexa L



Thickness : 20/30 mm
 Weight : 750/1 740 g
 1 pc : 0,16 m²
 6 pcs : 0,97 m²

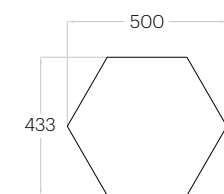

Hexa M



Thickness : 20/30 mm
 Weight : 480/1100 g
 1 pc : 0,10 m²
 10 pcs : 1,04 m²

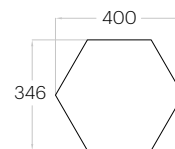

Hexa S



Thickness : 20/30 mm
 Weight : 250/580 g
 1 pc : 0,05 m²
 18 pcs : 0,97 m²

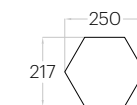

Tele Cut L*



Thickness : 20/30 mm
 Weight : 850/1980 g
 1 pc : 0,19 m²
 5 pcs : 0,93 m²

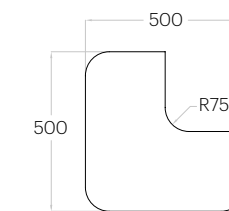

Tele Cut M*



Thickness : 20/30 mm
 Weight : 470/1100 g
 1 pc : 0,10 m²
 10 pcs : 1,03 m²

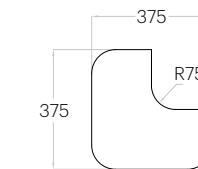

Tele Cut S*



Thickness : 20/30 mm
 Weight : 200/480 g
 1 pc : 0,04 m²
 22 pcs : 0,98 m²

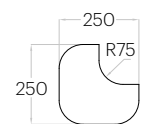

FIRE-RESIST / Pixel S

Echo L



Thickness : 20/30 mm
Weight : 820/1870 g
1 pc : 0,18 m²
6 pcs : 1,06 m²

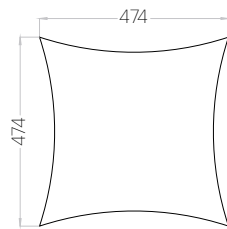

Echo M



Thickness : 20/30 mm
Weight : 510/1170 g
1 pc : 0,11 m²
9 pcs : 0,99 m²

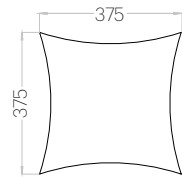

Echo S



Thickness : 20/30 mm
Weight : 230/520 g
1 pc : 0,05 m²
20 pcs : 0,98 m²

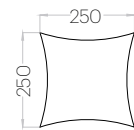

Bond



Thickness : 20/30 mm
Weight : 760/1740 g
1 pc : 0,16 m²
6 pcs : 0,96 m²

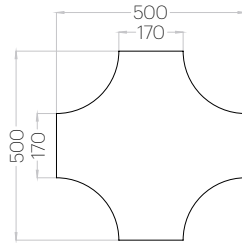

Triada



Thickness : 20/30 mm
Weight : 280/650 g
1 pc : 0,06 m²
16 pcs : 0,97 m²

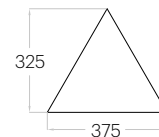

Line

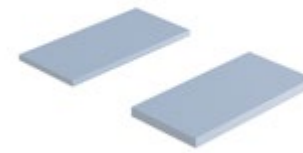

Thickness : 20/30 mm
Weight : 580/1 340 g
1 pc : 0,13 m²
8 pcs : 1,00 m²

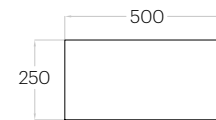

Dot L



Thickness : 20/30 mm
Weight : 900/2100 g
1 pc : 0,20 m²
5 pcs : 0,98 m²

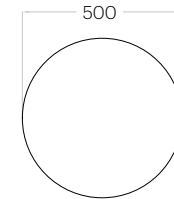

Dot M



Thickness : 20/30 mm
Weight : 480/1110 g
1 pc : 0,09 m²
12 pcs : 1,03 m²

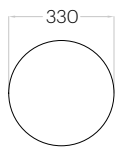

FIRE-RESIST / Pixel S

Hello L



Thickness : 20/30 mm
Weight : 1260/2900 g
1 pc : 0,27 m²
4 pcs : 1,09 m²

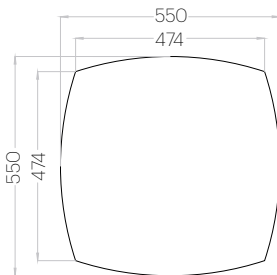

Hello M



Thickness : 20/30 mm
Weight : 790/1810 g
1 pc = 0,17 m²
6 pcs = 1,02 m²

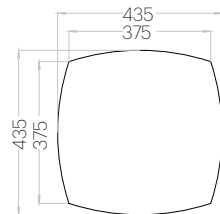

Hello S



Thickness : 20/30 mm
Weight : 350/810 g
1 pc = 0,08 m²
13 pcs = 0,98 m²

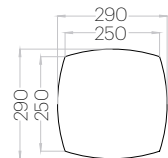

Shell



Thickness : 20/30 mm
Weight : 400/910 g
1 pc : 0,09 m²
11 pcs : 0,99 m²

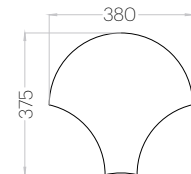

WEB

Acoustic curtains

WEB acoustic curtains serve several purposes: they effectively absorb sound, divide space visually at and constitute a unique decorative element. They are a great solution for those interiors where the installation of other acoustic materials is limited. Thanks to their openwork form and lightweight, they subtly divide space, and their colour and shape build the right ambience of the interior. The curtain can be mobile thanks to a specially selected rail.



Material

1. Fluffo finish
2. Polyurethane foam
3. Strap and snap rivets mounting system

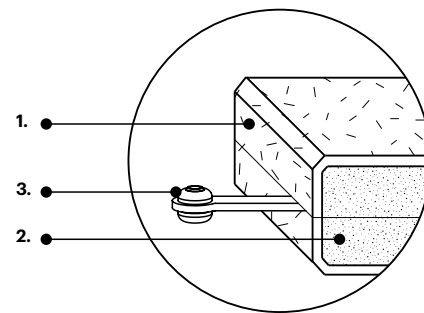

Acoustics

α_s Sound absorption coefficient according to PN-EN ISO 354:2005

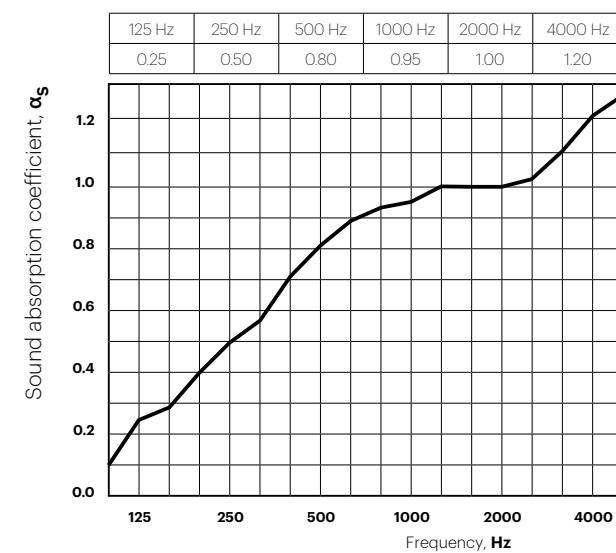

Sound absorption indicator according to PN-EN ISO 11654:1997 $\alpha_w = 0,80$

Sound absorption class: B

smart interior design

FOR YOUR OFFICE

WWW.SMARTINTERIOR.RO

Strada Ziduri Intre Vii, Nr 19, Corp A, Sector 2,
Bucuresti. Email: office@smartinterior.ro
tel: 0742220325 / 0733626222





Pixel M Edge

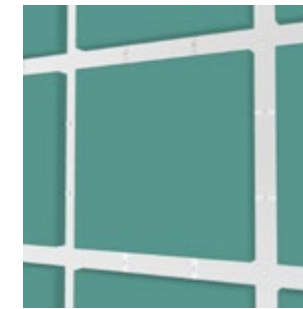

Thickness : 40 mm
Weight : 390 g
1 pc : 0,14m²

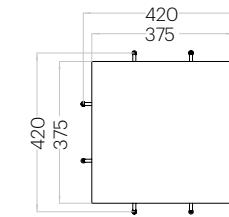

Tele M Edge

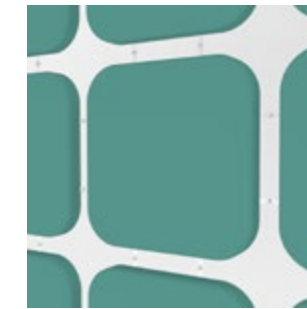

Thickness : 40 mm
Weight : 370 g
1 pc : 0,14 m²

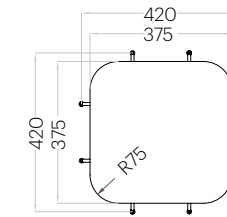

Hexa M Edge

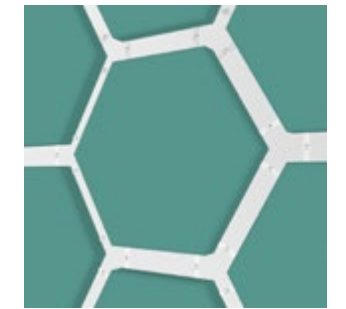

Thickness : 40 mm
Weight : 290 g
1 pc : 0,10 m²

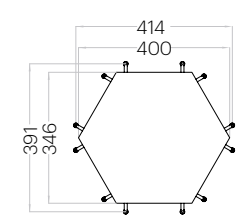

Pixel S Edge

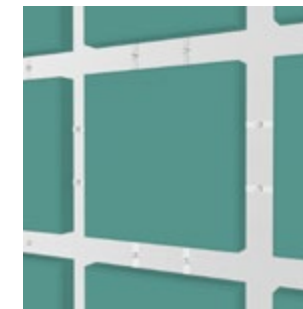

Thickness : 40 mm
Weight : 170 g
1 pc : 0,06 m²

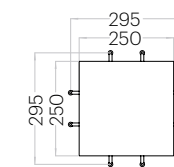

Tele S Edge

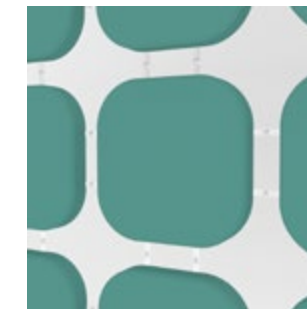

Thickness : 40 mm
Weight : 160 g
1 pc : 0,06 m²

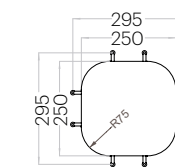

Hexa S Edge



Thickness : 40 mm
Weight : 110 g
1 pc : 0,04 m²

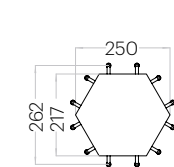

Flufo WEB / Dot L

Dot Edge

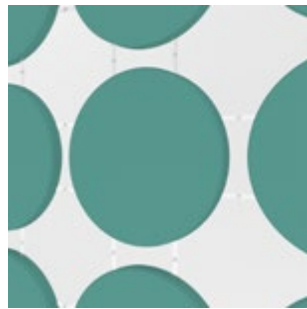

Thickness : 40 mm
Weight : 300 g
1 pc : 0,11 m²

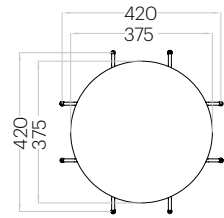

Spot Edge

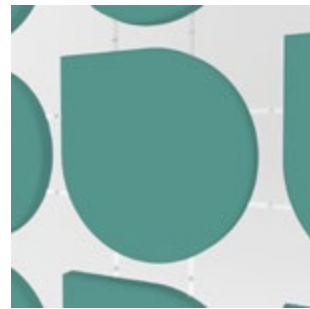

Thickness : 40 mm
Weight : 330 g
1 pc : 0,12 m²

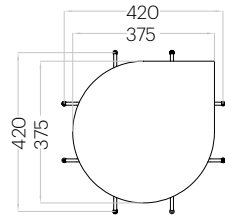

Caro Edge



Thickness : 40 mm
Weight : 380 g
1 pc : 0,14 m²

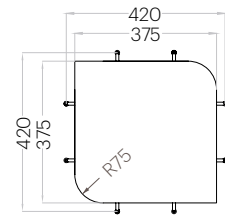

Shell Edge



Grubość (thickness): 40 mm
Waga (weight): 250 g
1 szt. (pc) : 0,09m²

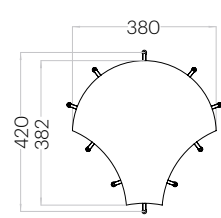

Bar Edge

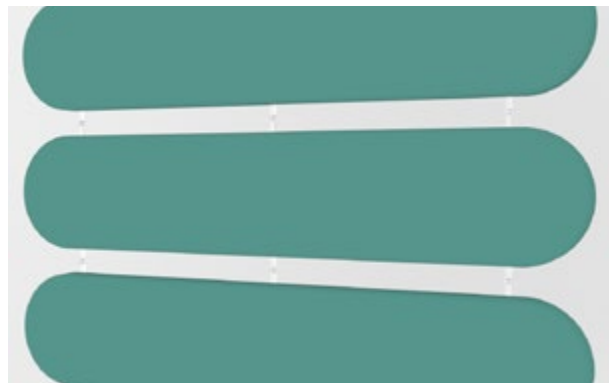

Thickness : 40 mm
Weight : 530 g
1 pc : 0,19 m²

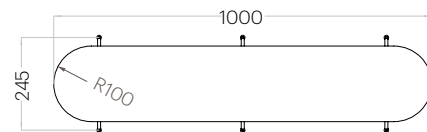

Stick Edge

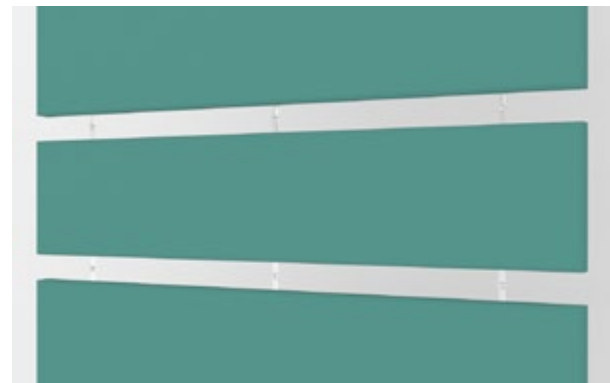

Thickness : 40 mm
Weight : 550 g
1 pc : 0,20 m²

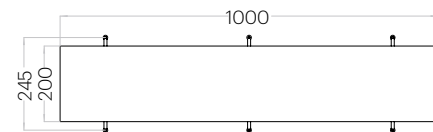

WEB installation.

WEB assembly is very simple. The curtain is hung on a special rail mounted to the ceiling, the panels are linked with plastic straps secured with snap rivets. Depending on the accessories used, the curtain can be mobile or fixed in place. The connecting strips between individual panels are made of very durable plastic, resistant to tearing or cracking. A set of the necessary accessories is included with the product.



snap rivets

smart interior design

FOR YOUR OFFICE

WWW.SMARTINTERIOR.RO

Strada Ziduri Intre Vii, Nr 19, Corp A, Sector 2,
Bucuresti. Email: office@smartinterior.ro
tel: 0742220325 / 0733626222

ART

Large-format wall panels

ART is a small art piece; it is the effect of cooperation with the young Polish designer, Joanna Kabala. It is the first single large-format panel in our portfolio, available in a wide range of colours and several shapes. It is not permanently affixed to the wall; it can be taken down and turned, or swapped with another piece of ART, allowing the creation of a unique composition every time. The entire collection was created with long corridors (often acoustically neglected), stair cases and large offices in mind. Where the wall needs a strong accent and the acoustics of the interior leave much to be desired.

smart interior design

FOR YOUR OFFICE

WWW.SMARTINTERIOR.RO

Strada Ziduri Intre Vii, Nr 19, Corp A, Sector 2,
Bucuresti. Email: office@smartinterior.ro
tel: 0742220325 / 0733626222



Material

1. Fluffo finish
2. Polyurethane foam
3. MDF
4. Mounting clips

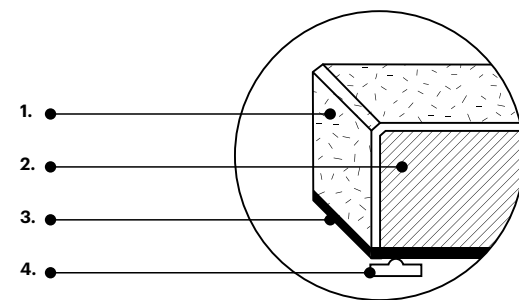

Acoustics

α_s Sound absorption coefficient according to PN-EN ISO 354:2005

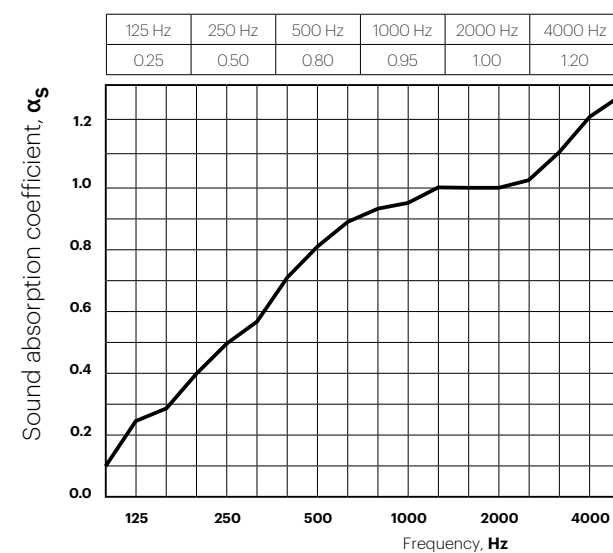

Sound absorption indicator according to PN-EN ISO 11654:1997 $\alpha_w = 0,80$

Sound absorption class: B



Art 1



Thickness : 56 mm
Weight : 10000 g
1 pc : 1,57 m2

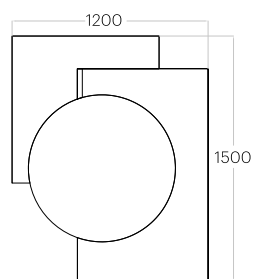

Art 2



Thickness : 56 mm
Weight : 8000 g
1 pc : 1,23 m2

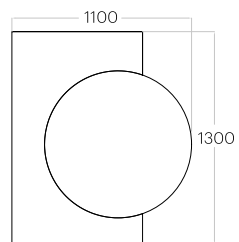

Art 3



Thickness : 56 mm
Weight : 7000 g
1 pc : 1,02 m2

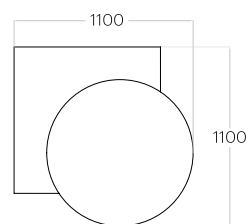

Art 4



Thickness : 56 mm
Weight : 5200 g
1 pc : 0,80 m2

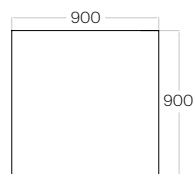

Art 5



Thickness : 56 mm
Weight : 6800 g
1 pc : 1,04 m2

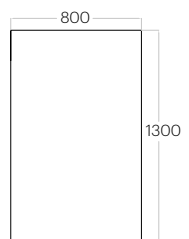

ART

ART installation.

ART panels are mounted on walls with the use of special mounting clips. This solution, allows for the panel to be repeatedly removed and reattached to the wall. The template and mounting accessories included with the product help to accurately position the mounting clips on the wall.



Mounting system

smart interior design

FOR YOUR OFFICE

WWW.SMARTINTERIOR.RO

Strada Ziduri Intre Vii, Nr 19, Corp A, Sector 2,
Bucuresti. Email: office@smartinterior.ro
tel: 0742220325 / 0733626222

AIR

Overhead elements

AIR - overhead panels will be ideal in large spaces such as: open space offices, wide corridors, and spacious halls, where the acoustic effect of wall panels will be limited. AIR is available in all colours and shapes. AIR will bring form and colour to the spacious interiors, significantly improving their acoustics.

smart interior design

FOR YOUR OFFICE

WWW.SMARTINTERIOR.RO

Strada Ziduri Intre Vii, Nr 19, Corp A, Sector 2,
Bucuresti. Email: office@smartinterior.ro
tel: 0742220325 / 0733626222



Material

1. Fluffo finish
2. High density glass wool panel secured with glass fibre

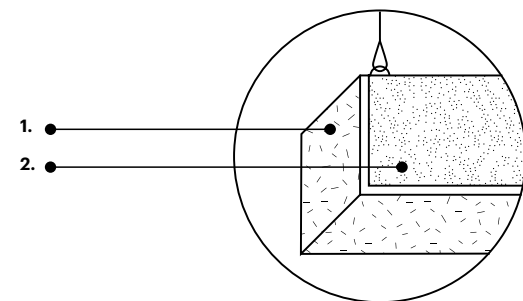

Acoustics

α_s , Sound absorption coefficient according to PN-EN ISO 354:2005

AIR, air gap 1000 mm.

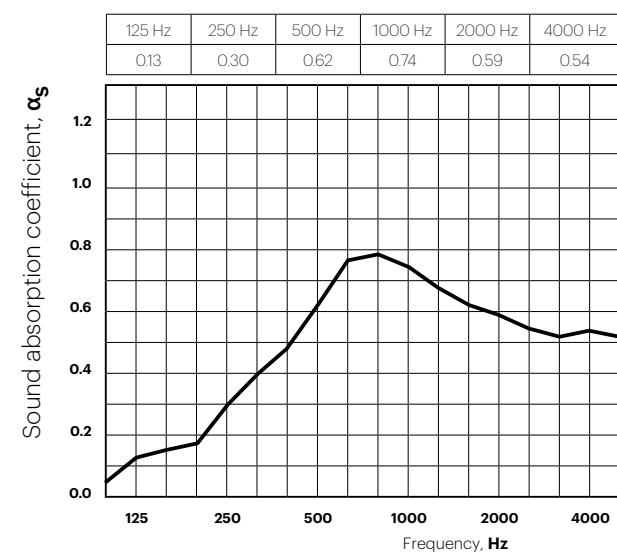

Sound absorption indicator according to PN-EN ISO 11654:1997

$\alpha_w = 0,60$

Sound absorption class: C



classification of fire resistance
PN-EN 135011+A1:2010 D-s1 d0;
Fire Retardant,
non-dripping.

Dot



Thickness : 40 mm

Weight): 2200 g
1 pc : 0,79 m²

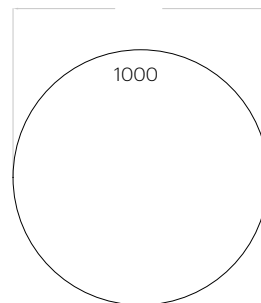

Pixel



Thickness : 40 mm
Weight : 2800 g
1 pc : 1,00m²

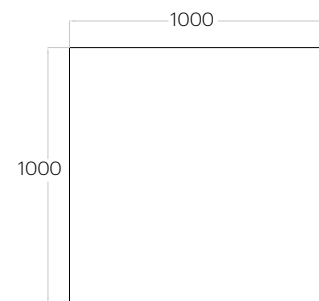

Tele



Thickness : 40 mm
Weight : 2800 g
1 pc : 0,99 m²

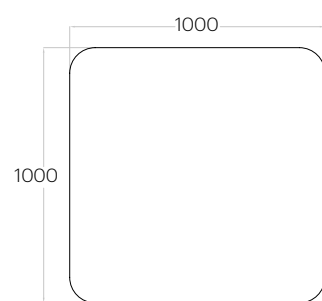

Hexa



Thickness : 40 mm
Weight : 1800 g
1 pc : 0,65m²

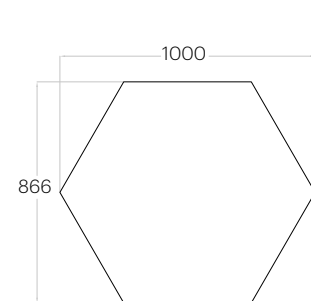

Echo



Thickness : 40 mm
Weight : 2200 g
1 pc : 0,79 m²

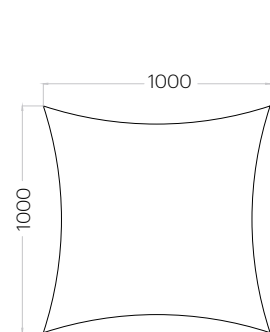

Hello

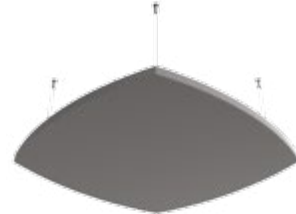

Thickness : 40 mm
Weight : 3100 g
1 pc = 1,12 m²

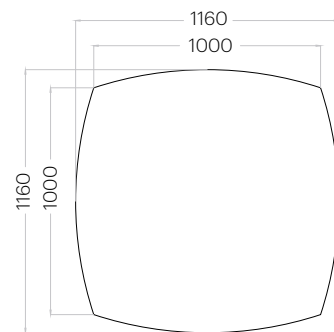

Octa



Thickness : 40 mm
Weight : 2300 g
1 pc = 0,83 m²

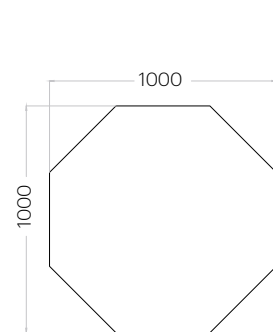

smart interior design

FOR YOUR OFFICE

WWW.SMARTINTERIOR.RO

Strada Ziduri Intre Vii, Nr 19, Corp A, Sector 2,
Bucuresti. Email: office@smartinterior.ro
tel: 0742220325 / 0733626222



AIR

AIR installation.

The panel is suspended from the ceiling with steel cables, which make it possible for the panels to be hung at various heights. Available accessories permit the installation of panels on concrete ceilings as well as suspended raster ceiling. A set of necessary accessories and assembly templates are included with the product.



Mounting system



smart interior design

FOR YOUR OFFICE

WWW.SMARTINTERIOR.RO

Strada Ziduri Intre Vii, Nr 19, Corp A, Sector 2,
Bucuresti. Email: office@smartinterior.ro
tel: 0742220325 / 0733626222

GLASS

Glass surface panels

GLASS acoustic panels with the unique suction cup mounting system for glass surface application. Wide range of colours and shapes make them the ideal, unique decoration for glass walls. GLASS panels absorb sound and reduce echoes within the interior, they will significantly improve the acoustics in glazed conference rooms or offices where windows occupy large surfaces. The suction cup mounting system will also hold panels on lacquered MDF commonly used in office furniture.



Material

1. Fluffo finish
2. Polyurethane foam
3. MDF
4. Suction cups

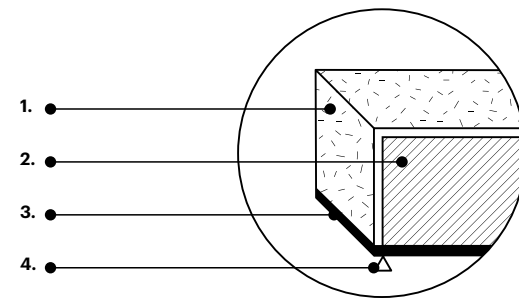

Acoustics

α_s Sound absorption coefficient according to PN-EN ISO 354:2005

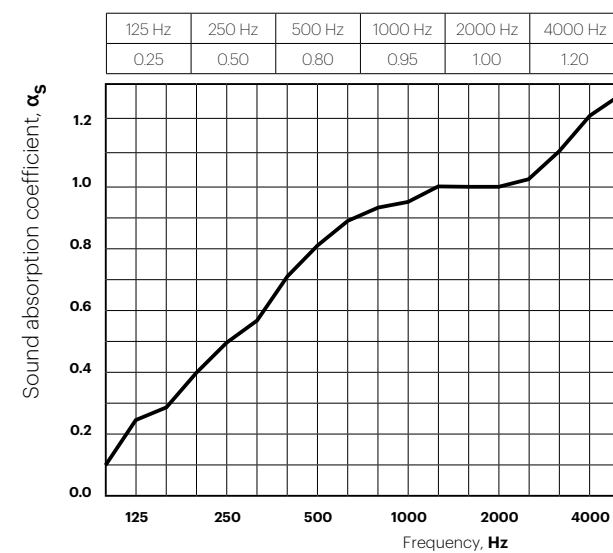

Sound absorption indicator according to PN-EN ISO 11654:1997 $\alpha_w = 0,80$

Sound absorption class: B

smart interior design

FOR YOUR OFFICE

WWW.SMARTINTERIOR.RO

Strada Ziduri Intre Vii, Nr 19, Corp A, Sector 2,
Bucuresti. Email: office@smartinterior.ro
tel: 0742220325 / 0733626222



GLASS / Dot L



GLASS / Dot L

Pixel L

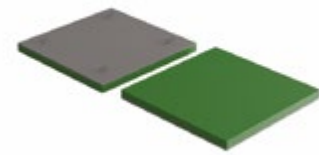

Thickness : 36 mm
Weight : 1200 g
1 pc : 0,25 m²
4 pcs : 1,00 m²

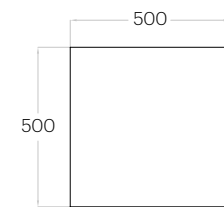

Tele L



Thickness : 36 mm
Weight : 1200 g
1 pc : 0,25 m²
4 pcs : 0,98 m²

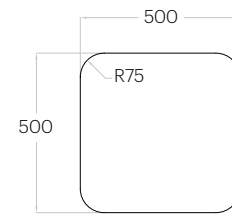

Hexa L

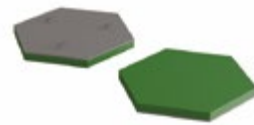

Thickness : 36 mm
Weight : 750 g
1 pc : 0,16 m²
6 pcs : 0,97 m²

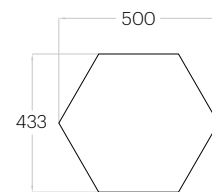

Dot L

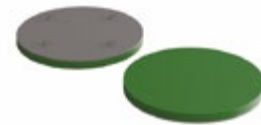

Thickness : 36 mm
Weight : 940 g
1 pc = 0,20 m²
5 pcs = 0,98 m²

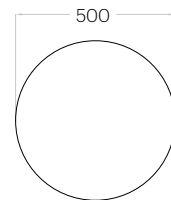

GLASS

GLASS installation.

Each Glass panel is equipped with a set of strong, transparent suction cups (5 cm in diameter). The panel should be pressed firmly against the glass in places where the suction cups are located. Glass can be mounted on glass, lacquered MDF and polished stoneware.

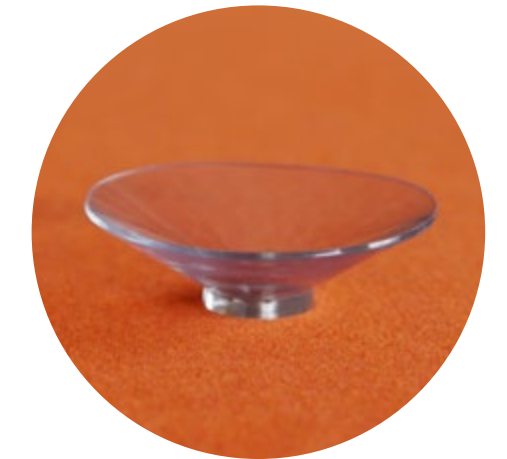

Suction caps

smart interior design

FOR YOUR OFFICE

WWW.SMARTINTERIOR.RO

Strada Ziduri Intre Vii, Nr 19, Corp A, Sector 2,
Bucuresti. Email: office@smartinterior.ro
tel: 0742220325 / 0733626222

GLASS / Dot L